

HIGOLD®

HIGOLD GROUP CO., LTD.
Kitchen Hardware Division

Add: No.36, Shunye East Road, Xingtan Town, Shunde District,
Foshan City, Guangdong Province, China, 528325, P.R.C
T: +86 757 2738 6292 F: +86 757 2738 0276
W: www.higold.com
www.higoldsink.com



HIGOLD®

KITCHEN SINK PRODUCT



HIGOLD KITCHEN SINK NEW CATALOGUE



WELCOME TO HIGOLD KITCHEN AND BATHROOM WORLD

HIGOLD®

DESIGN IS A PURSUIT
OF PERFECT LIFE ATTITUDE
DESIGN IS A PURSUIT
OF TASTE OF LIFE CONCEPT



BRAND HISTORY

2004

"Higold" was established to engage in hardware processing and export by renting a 1,500 square meters factory in Nanlang, Xintan town.

2005

For long-term development, Higold fully designed the brand CI system.
Brand positioning "kitchen functional hardware", mainly for export.
Higold Outdoor Furniture Company was established, and began to enter the field of outdoor furniture and explore diversified development.

2006

The factory was relocated to Xingtang East Village and expanded to 15,000 m².

2007

Higold began to enter the Chinese market; functional hardware products such as corner and tall cabinet units were successfully developed and put into production;
Established cooperation with several well-known customers in the industry of domestic cabinet.

2008

Survived the Asian financial crisis, Higold was determined to focus on domestic sales, supplemented by exports, and focus on design and branding as the core of development.

2010

Became the Top 10 enterprise of kitchen and bathroom accessories in China.

2012

Awarded Shunde Longteng Enterprise. Higold production base was expanded to 40,000 square meters; products were sold to 56 countries and regions around the world;
The outdoor furniture company participated in the SPOGA exhibition in Cologne, Germany, with a booth of 150 square meters;
Higold furniture showed its original design to the world with its own brand.

2013

Higold Kitchenware Company was established, and the product line was extended to kitchen hardware such as sinks and faucets.

2014

The opening of flagship store of outdoor furniture with an area of 1000 m² in Amsterdam, Netherlands;
Higold E-Commerce Company was established, and products were sold on e-commerce platforms such as Tmall and JD.com.

2015

Higold brand experience pavilions were set up in 70 cities in China; Hardware and furniture products were sold to 86 countries worldwide.
The second production base for functional household hardware was put into operation;
Awarded National High-tech Enterprise;
Higold was selected as the drafting unit of the national standard of "Household Kitchen Equipment".

2016

Advertisements of Higold were displayed in Times Square, New York, USA.
Higold was assigned to be the "Executive President Unit" of China National Hardware Association;
Higold Hardware, which set up agencies over 100 cities in China, indirectly sells products to customers through over 10k special kitchen cabinet stores.

2017

The third production base was built in Shunde High-Tech Zone, and the plant was expanded by 200,000 m²; With first-class original design, Higold Outdoor Furniture Company has continuously opened brand stores in Netherlands, Italy, Dubai, the United States, Australia, Malaysia, etc., and enjoyed a worldwide reputation."Pininfarina and Higold reached a long-term strategic cooperation, injecting a constant internal drive for Higold's originality. Higold won the invention patent of Mini outdoor Mobile Toaster Oven and was sold around the globe through Metro and Walmart.
Higold was selected as the main drafting unit of the group standard of "Functional Hardware Basket for Home Use".

2018

Higold's Star Headquarters is the first original designed building in China by the Italian Ferrari design partner Pininfarina team which attract people's attention. The new headquarters are going to be Higold's product innovation R&D centre and new business model operation centre. Higold's outdoor furniture series were gradually expanded to outdoor ovens and outdoor umbrellas;

2019

The Chairman of Higold Group, Mr. Alwin Ou, was awarded the title of "Advanced Entrepreneur of the New Era" by the government; he was selected as a honorary winner in the "China Home Furnishing Industry Hall of Fame" by China National Furniture Association;
Higold's intelligent purification sink, which can solve food safety problems, has been featured in CCTV's programme "Consumer Advocate".

2020

Awarded Manufacturing Single Champion Enterprise in Foshan High-tech Zone;
Signed international superstar Donnie Yen as the brand spokesman, starting the journey of strong cooperation.
Higold Group's brand strategy development reached a new height;
"2020 iF design award: Higold outdoor furniture ONDA series;
Higold Group became the sole agent of GRASS hardware in China, which set off a new climax in the high-end brand market of Chinese hardware;
Became a joint laboratory support unit of the Chinese Academy of Sciences.

2021

Awarded the Certificate of The National Quality Inspection: Stable and Qualified Products issued by China Association for Quality Inspection;
The rooftop sealing of Higold Group's Star Headquarters was successfully carried out;
Higold's intelligent manufacturing base of home hardware laid the foundation stone, focusing on building a group of digital production site of 340,000m².
Higold Shearer 4.0 obtained the Chinese invention patent, successfully breaking the technology monopoly of European companies in same type of products.

2022

The Higold redefines its goal: to become a world-renowned home hardware brand. The product line will be developed from partial hardware to whole house hardware, including functional hardware, basic hardware, door and window hardware, kitchen and bathroom hardware, decorative hardware, smart hardware, outdoor furniture, becoming an one-stop solution provider of high-end hardware. The Higold Star Headquarters were fully completed and put into operation and has also become a favorite hall for designers to visit.
Higold's intelligent manufacturing base of home hardware iE No. 1 Factory was topped out. The total construction area is over 180,000 m², which is an industry-leading factory.
Higold Multi-functional Purification Kitchen Sink won the Chinese invention patent.

BRAND HONOR

The winner of 2014 Red Dot Award

Won the 2014 Red Dot Award-the "Oscar" of global design industry
HIGOLD shenzhou-10 space capsule received this award

The winner of 2017 Red Dot Award

The Water Dispens Won the 2017 Red Dot Award

The winner of 2018 Red Dot Award

Won the 2018 Red Dot Award-the "Oscar" of global design industry
HIGOLD kitchen intelligent mini oven won this award

The winner of 2021 Red Dot Award

Won the 2021 Red Dot Award-the "Oscar" of global design industry
Higold Shearer 4.0 Series Was Awarded The "reddot Awards" It Is The Fourth Time For Higold Group To Be Awarded

The winner of 2022 RedDot Award

Higold's Piniz Faucet 2.0 Won The 2022 Red Dot Award-the "Oscar" Of Global Design Industry

The winner of 2022 RedDot Award

Higold Multifunctional Purification Kitchen Sink Won The 2022 Red Dot Award-the "Oscar" Of Global Design Industry

The winner of 2020 iF Design Award

"ONDA" Series from HIGOLD Outdoor furniture is awarded "iF product design award" in Germany

The winner of 2021 iF Design Award

Higold Shearer 4.0 Series won the Germany iF Design Award

The winner of 2021 iF Design Award

Higold BN faucet 1.0 won the Germany iF Design Award

The winner of 2022 iF Design Award

Higold BN faucet 2.0 won the 2022 German iF Design Award

The winner of 2022 iF Design Award

Higold Multifunctional Purification Kitchen Sink won the 2022 German iF Design Award

The winner of 2022 iF Design Award

Higold P10 integrated sink dishwasher was awarded the 2022 German iF Design Award

National high and new technology enterprise

Provincial industrial design center

Top 10 Hardware Industry

China's Top 500 Home Furnishing Manufacturing Industries In 2020



reddot design award
winner 2014

2014 Reddot Design
Award



reddot design award
winner 2017

2017 Reddot Design
Award



reddot design award
winner 2018

2018 Reddot Design
Award



reddot design award
winner 2021

2021 Reddot Design
Award



reddot design award
winner 2022

2022 Reddot Design
Award



reddot design award
winner 2022

2022 Reddot Design
Award



Design Award 2020



Design Award 2021



Design Award 2021



Design Award 2022



Design Award 2022



Design Award 2022



Red Star Design Award



Red Star Design Award



Design Award China



The Pinnacle Awards
Asia-pacific



Gloden Hook Prize



Top ten Chinese
enterprises of kitchen
and bathroom
accessories



National High-Tech
Enterprise



National Standards
Maker of Kitchen
Hardware Industry



Brief introduction of HIGOLD GROUP Co., Ltd

Higold Group Co., Ltd., founded in 2004, is a diversified and innovative technology enterprise, focusing on home hardware, business including functional hardware, furniture fittings, door and window hardware, kitchen and bathroom hardware, decorative hardware, smart hardware, and outdoor furniture, dedicated to creating one-stop full house high-end hardware solutions for global users. As a high-end brand in China's home hardware industry, its brand awareness and sales scale have always been in a leading position in China. In 2020, Higold signed a contract with Donnie Yen as the brand spokesperson, starting a new journey for the global national brand.

Since its establishment, Higold has always adhered to the strategy of integration of production, research and marketing. It is building manufacturing base of 340,000 square meters, which is the large-scale intelligent manufacturing base of home hardware in Asia nowadays. With more than 30,000 square meters, Higold Star Headquarters stands in China with a unique architectural design posture in the world. Its avant-garde, high-tech, dynamic and fashionable design elements attracts people's attention.

As a national high-tech enterprise, Higold has a strong engineering technology center and research institute, and long-term strategic cooperation with many top design companies around the world, integrating global high-quality research and innovation resources, providing continuous driving force for "creative living · soul".

Up to now, Higold has more than 700 patents. It is the main drafting unit of the group standard of "Functional Hardware Basket for Home Use" and the drafting unit of the national standard of "Household Kitchen Equipment". Its products have won the Red Dot Design Award, iF Design Award, China Red Star Award and other domestic and foreign awards for many times. The group has been awarded "Top 10 Kitchen and Bathroom Accessories Enterprises in China", "Top 10 Hardware Industry in China home Manufacturing industry", "Top 100 Foshan Manufacturing Industry in 2021" and many other honors.

























Higold products are sold to 90 countries and regions in the world, and its sales network covers the whole world. It has hundreds of agents in domestic cities and also is a strategic partner of many well-known real estate industry brands and home furnishing brands in China.

Higold is renowned for its excellent quality and innovative design in the industry, and is committed to building a leading world-class aircraft carrier for home furnishing and hardware, striving to improve the quality of human life.









Founder & President of the HIGOLD group
Mr. Alwin Ou

SALES NETWORK





ASIA

	China	Beijing
	India	New Delhi
	Saudi Arabia	Riyadh
	Korea	Seoul
	UAE	Dubai
	Thailand	Bangkok
	Malaysia	Kuala Lumpur
	Singapore	Singapore
	Vietnam	Hanoi
	Philippines	Manila
	Indonesia	Jakarta
	Iran	Tehran
	Iraq	Baghdad
	Qatar	Doha
	Lebanon	Beirut
	Pakistan	Karachi
	Oman	Muscat
	Kuwait	Kuwait
	Syria	Damascus
	Jordan	Amman
	Bahrain	Manama
	Palestine	East Jerusalem
	Brunei	Bandar Seri Begawan
	Myanmar	Mandalay
	Cambodia	Phnom Penh
	Sri Lanka	Colombo

EUROPE

	Austria	Linz
	France	Paris
	Germany	Hamburg
	Italy	Rome
	Holland	Rotterdam
	Russia	Moscow
	Spain	Barcelona
	Switzerland	Bern
	UK	London
	Ukraine	Kiev
	Denmark	Copenhagen
	Sweden	Stockholm
	Norway	Oslo
	Finland	Helsinki
	Portugal	Lisbon
	Greece	Athens
	Belgium	Brussels
	Poland	Warsaw







AFRICA

	Egypt	Cairo
	South Africa	Cape Town
	Algeria	Algiers
	Nigeria	Lagos Nigeria
	Libya	Tripoli





OCEANIA

	Australia	Sydney
	Newzealand	Auckland

SOUTH AMERICA

	Brazil	Sao Paulo
	Columbia	Bogota
	Argentina	Buenos Aires
	Chile	Santiago
	Peru	Lima
	Bolivia	La Paz
	Ecuador	Quito

NORTH AND CENTRAL AMERICA

	Canada	Toronto
		Vancouver
		Montreal
	Mexico	Mexico City
	America	New York
		Los Angeles
		Chicago
		Houston
		Philadelphia
		San Francisco
		Atlanta
		Boston
	Panama	Panama

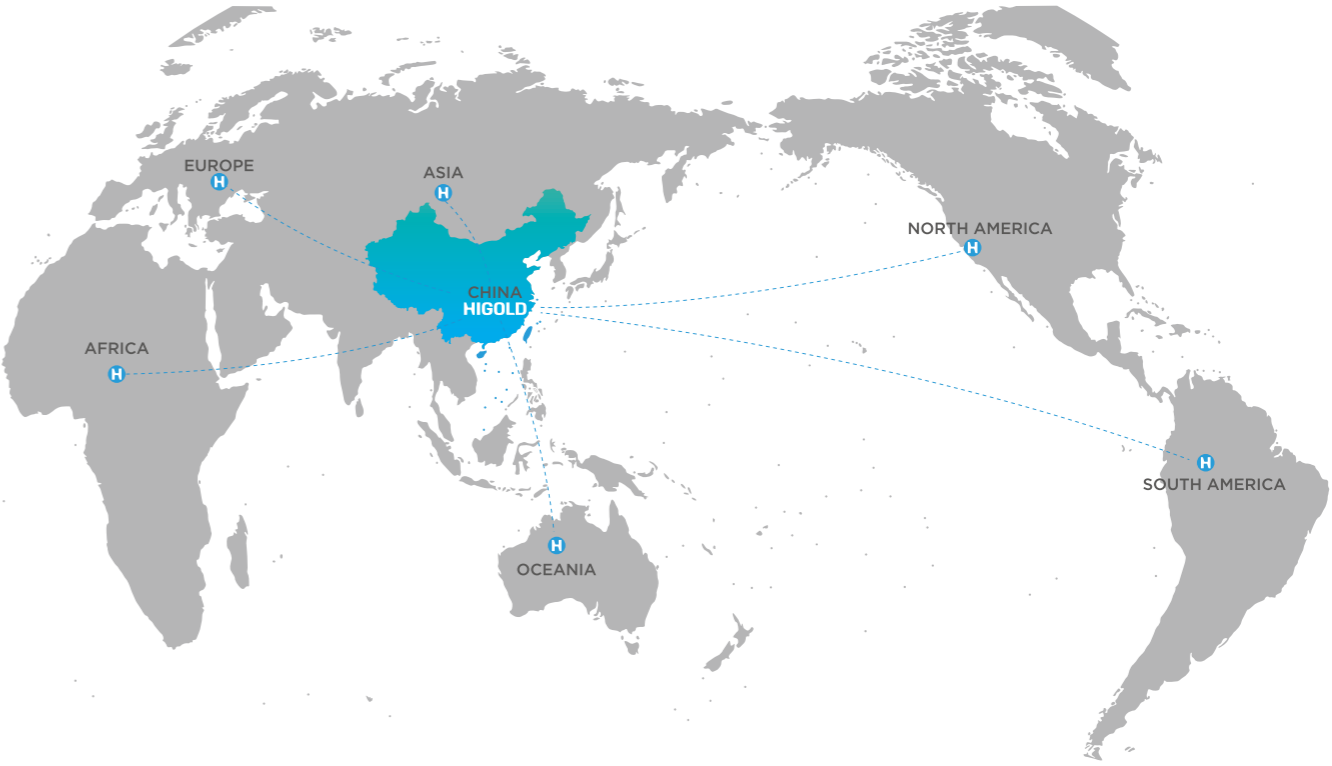



HIGOLD KITCHEN SINK NEW CATALOGUE

MENU

015	HANDMADE SINKS
049	KITCHEN CHANNEL SINKS
055	INTELLIGENT PURIFICATION SINKS
061	PRESSING SINKS
085	KITCHEN FAUCETS
099	ACCESSORIES
105	BATHROOM SINKS
107	BASIN FAUCETS
117	SHOWERS

REFERENCE PALETTE

Light luxury experience, detail presentation, high-end quality, fashion color. Fine "wash" the kitchen and bathroom, pay attention to the nuances, taste the ordinary life, feel the warm home, have originality and still have more meaning.

Full of metal texture of the thick and solid, all maintain cool and cool design style, firm edges and corners, handsome clear, showing modern quality of private life style.



Gunmetal black



SS Raw Finising



Rose gold



Nano Grey



Matted black



white



Grey

The details into a song
The life into a poem
Happiness comes from
the details

Every color is the love of
the kitchen, and every
detail is the pursuit of
life



HANDMADE SINKS

Neat, ordinary, but practical, these are the main characters that define Higold Regular Handmade Sink Collection. "Making the ordinary extraordinary", Higold is on the way all the time



ART.NO. **951393**

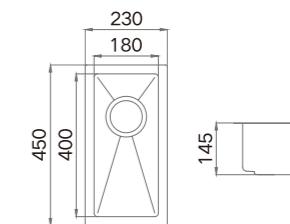

● Black ● Gold ● Rosy

Information

Product Dimension (LxWxD)	230x450x145mm
Material	SUS304
Thickness	1.0mm
Corner	Radius 10
Cutout Size (Topmount)	210x430mm (R0)
Cutout Size (Undermount)	183x403mm (R12)

Description

Brushed surface;
Single bowl;
With sound pad and undercoating;
Optional accessories:
Drainer, colander, chopping board, grid,
Rollmat, soap dispenser, wire basket, etc.

ART.NO. **951394**

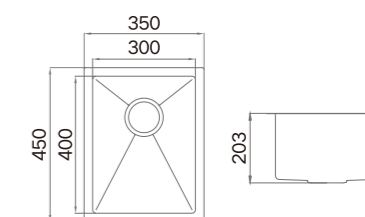

● Black ● Gold ● Rosy

Information

Product Dimension (LxWxD)	350x450x203mm
Material	SUS304
Thickness	1.0mm
Corner	Radius 10
Cutout Size (Topmount)	330x430mm (R0)
Cutout Size (Undermount)	303x403mm (R12)

Description

Brushed surface;
Single bowl;
With sound pad and undercoating;
Optional accessories:
Drainer, colander, chopping board, grid,
Rollmat, soap dispenser, wire basket, etc.

ART.NO. **951395**

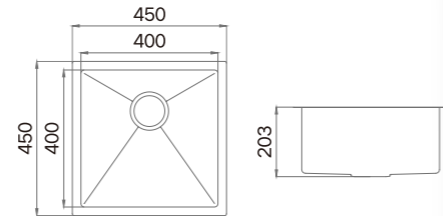

Information

Product Dimension (LxWxD)	450x450x203mm
Material	SUS304
Thickness	1.0mm
Corner	Radius 10
Cutout Size (Topmount)	430x430mm (R0)
Cutout Size (Undermount)	403x403mm (R12)

Description

Brushed surface;
Single bowl;
With sound pad and undercoating;
Optional accessories:
Drainer, colander, chopping board, grid,
Rollmat, soap dispenser, wire basket, etc.

ART.NO. **951397**

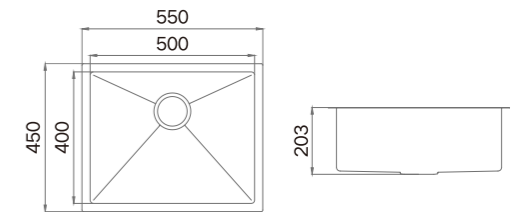

Information

Product Dimension (LxWxD)	550x450x203mm
Material	SUS304
Thickness	1.0mm
Corner	Radius 10
Cutout Size (Topmount)	530x430mm (R0)
Cutout Size (Undermount)	503x403mm (R12)

Description

Brushed surface;
Single bowl;
With sound pad and undercoating;
Optional accessories:
Drainer, colander, chopping board, grid,
Rollmat, soap dispenser, wire basket, etc.

ART.NO. **951396**

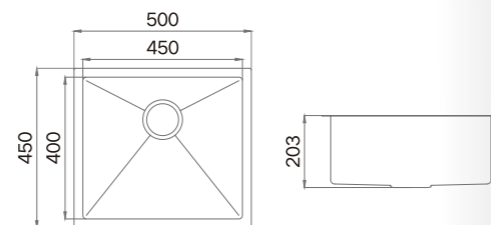

Information

Product Dimension (LxWxD)	500x450x203mm
Material	SUS304
Thickness	1.0mm
Corner	Radius 10
Cutout Size (Topmount)	480x430mm (R0)
Cutout Size (Undermount)	453x403mm (R12)

Description

Brushed surface;
Single bowl;
With sound pad and undercoating;
Optional accessories:
Drainer, colander, chopping board, grid,
Rollmat, soap dispenser, wire basket, etc.

ART.NO. **952424**

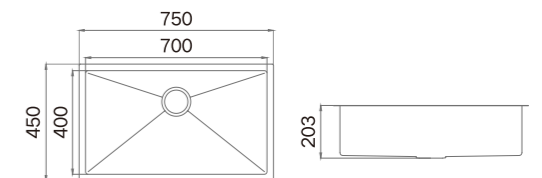

Information

Product Dimension (LxWxD)	750x450x203mm
Material	SUS304
Thickness	1.0mm
Corner	Radius 10
Cutout Size (Topmount)	730x430mm (R0)
Cutout Size (Undermount)	703x403mm (R12)

Description

Brushed surface;
Single bowl;
With sound pad and undercoating;
Optional accessories:
Drainer, colander, chopping board, grid,
Rollmat, soap dispenser, wire basket, etc.

HANDMADE SINKS

Like A Ray Of Sunlight
Fuel Your Hope On A Dream Life.

A Sink of Higold,
Fulfill your fantasy for a perfect kitchen.



ART.NO. **953485**

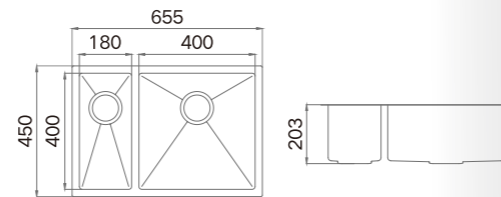

● Black ● Gold ● Rosy

Information

Product Dimension (LxWxD)	655x450x203mm
Material	SUS304
Thickness	1.0mm
Corner	Radius 10
Cutout Size (Topmount)	635x430mm (R0)
Cutout Size (Undermount)	608x403mm (R12)

Description

Brushed surface;
 Double bowl;
 With sound pad and undercoating;
 Optional accessories:
 Drainer, colander, chopping board, grid,
 Rollmat, soap dispenser, wire basket, etc.

ART.NO. **953487**

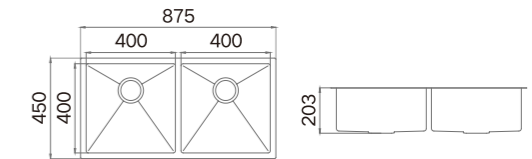
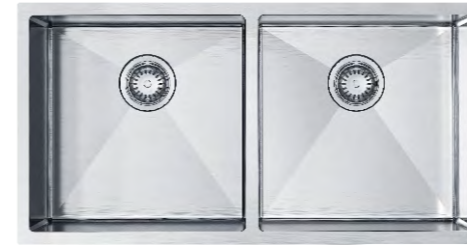

● Black ● Gold ● Rosy

Information

Product Dimension (LxWxD)	875x450x203mm
Material	SUS304
Thickness	1.0mm
Corner	Radius 10
Cutout Size (Topmount)	855x430mm (R0)
Cutout Size (Undermount)	828x403mm (R12)

Description

Brushed surface;
 Double bowl;
 With sound pad and undercoating;
 Optional accessories:
 Drainer, colander, chopping board, grid,
 Rollmat, soap dispenser, wire basket, etc.

ART.NO. **953486**

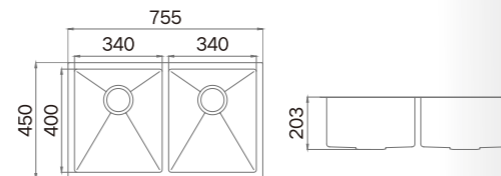

● Black ● Gold ● Rosy

Information

Product Dimension (LxWxD)	755x450x203mm
Material	SUS304
Thickness	1.0mm
Corner	Radius 10
Cutout Size (Topmount)	735x430mm (R0)
Cutout Size (Undermount)	708x403mm (R12)

Description

Brushed surface;
 Double bowl;
 With sound pad and undercoating;
 Optional accessories:
 Drainer, colander, chopping board, grid,
 Rollmat, soap dispenser, wire basket, etc.

Break then recreate

THAT IS HOW WE DEFINE INNOVATION

Topmount thick panel sink collection,
features the perfect balance of premium quality and reasonable cost.
To break apart the traditional integration of rim and bowl of a sink,
and recreate it with 2.5mm thick panel for the rim to ensure the strength
and stability of the whole sink structure,
while the bowls are crafted with 0.9mm steel sheet which not only
achieves cost efficiency but also easy to handle.



ART.NO. **951398**



● Black ● Gold ● Rosy

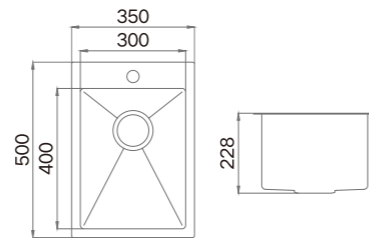

Information

Product Dimension (LxWxD)	350x500x228mm
Material	SUS304
Thickness	2.5+0.9mm
Corner	Radius 10
Cutout Size (Topmount)	330x480mm(R0)
Cutout Size (Undermount)	303x403mm (R12)

Description

Brushed surface;
Single bowl;
With sound pad and undercoating;
Optional accessories:
Drainer, colander, chopping board, grid,
Rollmat, soap dispenser, wire basket, etc.

ART.NO. **951400**



● Black ● Gold ● Rosy

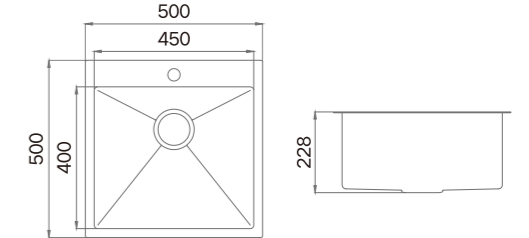

Information

Product Dimension (LxWxD)	500x500x228mm
Material	SUS304
Thickness	2.5+0.9mm
Corner	Radius 10
Cutout Size (Topmount)	480x480mm (R0)
Cutout Size (Undermount)	453x403mm (R12)

Description

Brushed surface;
Single bowl;
With sound pad and undercoating;
Optional accessories:
Drainer, colander, chopping board, grid,
Rollmat, soap dispenser, wire basket, etc.

ART.NO. **951399**



● Black ● Gold ● Rosy

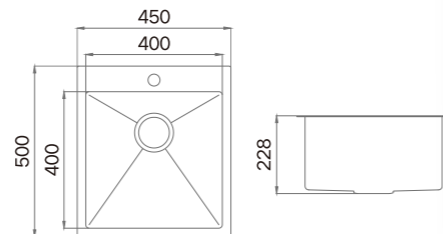

Information

Product Dimension (LxWxD)	450x500x228mm
Material	SUS304
Thickness	2.5+0.9mm
Corner	Radius 10
Cutout Size (Topmount)	430x480mm (R0)
Cutout Size (Undermount)	403x403mm (R12)

Description

Brushed surface;
Single bowl;
With sound pad and undercoating;
Optional accessories:
Drainer, colander, chopping board, grid,
Rollmat, soap dispenser, wire basket, etc.

ART.NO. **951401**



● Black ● Gold ● Rosy

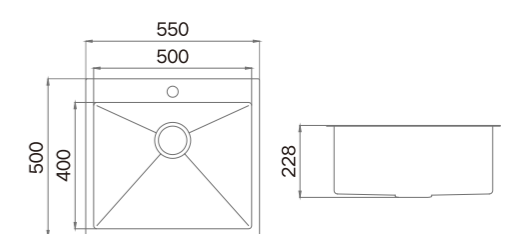

Information

Product Dimension (LxWxD)	550x500x228mm
Material	SUS304
Thickness	2.5+0.9mm
Corner	Radius 10
Cutout Size (Topmount)	530x480mm (R0)
Cutout Size (Undermount)	503x403mm (R12)

Description

Brushed surface;
Single bowl;
With sound pad and undercoating;
Optional accessories:
Drainer, colander, chopping board, grid,
Rollmat, soap dispenser, wire basket, etc.

ART.NO. **952425**

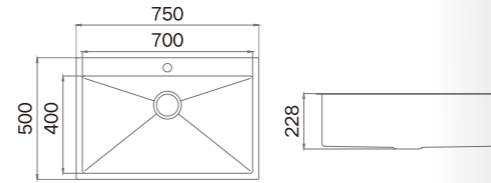

● Black ● Gold ● Rosy

Information

Product Dimension (LxWxD)	750x500x228mm
Material	SUS304
Thickness	2.5+0.9mm
Corner	Radius 10
Cutout Size (Topmount)	730x480mm(R0)
Cutout Size (Undermount)	703x403mm (R12)

Description

Brushed surface;
Single bowl;
With sound pad and undercoating;
Optional accessories:
Drainer, colander, chopping board, grid,
Rollmat, soap dispenser, wire basket, etc.

ART.NO. **953489**

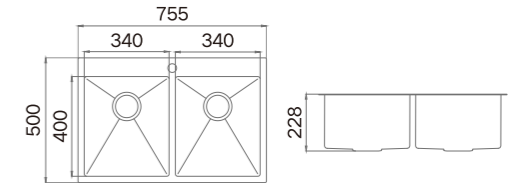

● Black ● Gold ● Rosy

Information

Product Dimension (LxWxD)	755x500x228mm
Material	SUS304
Thickness	2.5+0.9mm
Corner	Radius 10
Cutout Size (Topmount)	735x480mm (R0)
Cutout Size (Undermount)	708x403mm (R12)

Description

Brushed surface;
Double bowl;
With sound pad and undercoating;
Optional accessories:
Drainer, colander, chopping board, grid,
Rollmat, soap dispenser, wire basket, etc.

ART.NO. **953488**

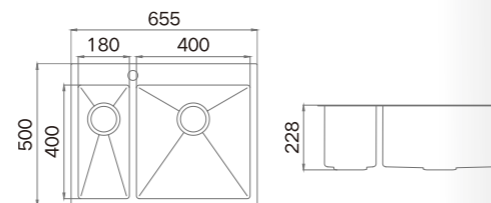

● Black ● Gold ● Rosy

Information

Product Dimension (LxWxD)	655x500x228mm
Material	SUS304
Thickness	2.5+0.9mm
Corner	Radius 10
Cutout Size (Topmount)	635x480mm (R0)
Cutout Size (Undermount)	608x403mm (R12)

Description

Brushed surface;
Double bowl;
With sound pad and undercoating;
Optional accessories:
Drainer, colander, chopping board, grid,
Rollmat, soap dispenser, wire basket, etc.

ART.NO. **953490**

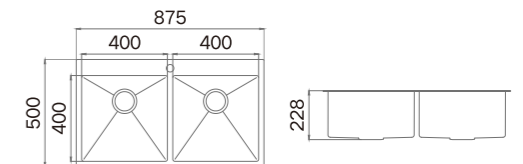

● Black ● Gold ● Rosy

Information

Product Dimension (LxWxD)	875x500x228mm
Material	SUS304
Thickness	2.5+0.9mm
Corner	Radius 10
Cutout Size (Topmount)	855x480mm (R0)
Cutout Size (Undermount)	828x403mm (R12)

Description

Brushed surface;
Double bowl;
With sound pad and undercoating;
Optional accessories:
Drainer, colander, chopping board, grid,
Rollmat, soap dispenser, wire basket, etc.



FARMHOUSE SINKS

Classical & legendary, that's how we describe Higold Apron Sinks, which is also named "Farmhouse Sink".

Never mean to stay in low-key, Higold Apron sinks are born to be luxurious and respectable.



ART.NO. **957039**

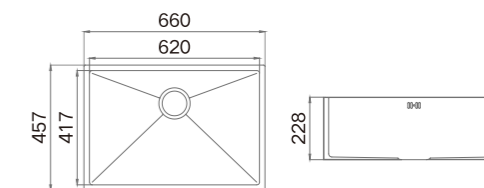

● Black ● Gold ● Rosy

Information

Product Dimension (LxWxD)	660x457x228mm
Material	SUS304
Thickness	1.35+1.2mm
Corner	Radius 10
Cutout Size (Topmount)	660x377mm (R0)

Description

Brushed surface;
Single bowl with apron;
With sound pad and undercoating;
Optional accessories:
Drainer, colander, chopping board, grid,
Rollmat, soap dispenser, wire basket, etc.

ART.NO. **957015**

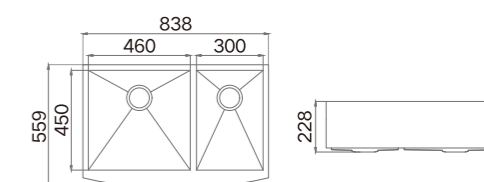

● Black ● Gold ● Rosy

Information

Product Dimension (LxWxD)	838x559x228mm
Material	SUS304
Thickness	1.35+1.2mm
Corner	Radius 0
Cutout Size (Topmount)	840x510mm (R0)

Description

Brushed surface;
Double bowl with apron;
With sound pad and undercoating;
Optional accessories:
Drainer, colander, chopping board, grid,
Rollmat, soap dispenser, wire basket, etc.

ART.NO. **957023**

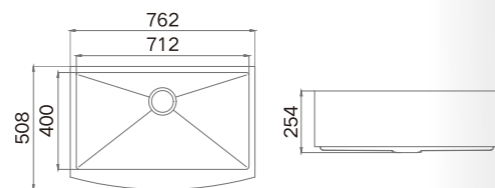

Information

Product Dimension (LxWxD)	762x508x254mm
Material	SUS304
Thickness	1.35+1.2mm
Corner	Radius 10
Cutout Size (Topmount)	768x457mm(R0)

Description

Brushed surface;
Single bowl with apron;
With sound pad and undercoating;
Optional accessories:
Drainer, colander, chopping board, grid,
Rollmat, soap dispenser, wire basket, etc.

ART.NO. **957026**

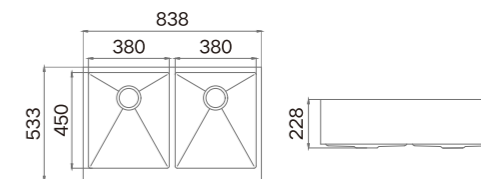

Information

Product Dimension (LxWxD)	838x533x228mm
Material	SUS304
Thickness	1.35+1.2mm
Corner	Radius 10
Cutout Size (Topmount)	840x513mm(R0)

Description

Brushed surface;
Double bowl with apron;
With sound pad and undercoating;
Optional accessories:
Drainer, colander, chopping board, grid,
Rollmat, soap dispenser, wire basket, etc.

ART.NO. **957025**

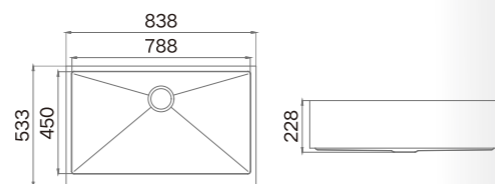

Information

Product Dimension (LxWxD)	838x533x228mm
Material	SUS304
Thickness	1.35+1.2mm
Corner	Radius 10
Cutout Size (Topmount)	840x513mm(R0)

Description

Brushed surface;
Single bowl with apron;
With sound pad and undercoating;
Optional accessories:
Drainer, colander, chopping board, grid,
Rollmat, soap dispenser, wire basket, etc.



ANGAS B1 SERIES SINK

Fully release the space in the bowl.

Dual-step dislocation design,
Create a multi-functional storage platform.



Driving by continuous innovation, Higold B1 Collection is born to re-shape your concept of a traditional working station sink. Whoever you are, a perfectionist or a pragmatist, Higold B1 Collection Sink is just for you.

ART.NO. **952367**

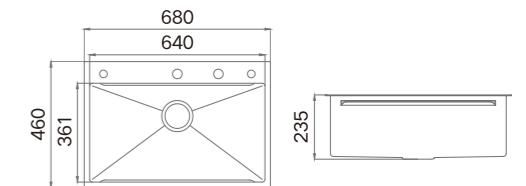

Information

Product Dimension (LxWxD)	680x460x235mm
Material	SUS304
Thickness	2.5+0.8mm
Corner	Radius 10
Cutout Size (Topmount)	660x440mm (R0)
Cutout Size (Undermount)	643x431mm (R12)

Standard Accessories



984223C

ART.NO. **952370**

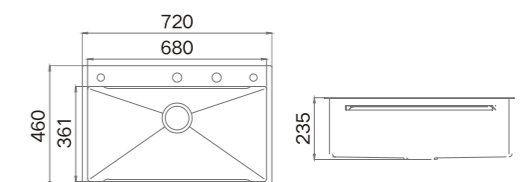

Information

Product Dimension (LxWxD)	720x460x235mm
Material	SUS304
Thickness	2.5+0.8mm
Corner	Radius 10
Cutout Size (Topmount)	700x440mm (R0)
Cutout Size (Undermount)	683x431mm (R12)

Standard Accessories



984223C

ART.NO. **952373**

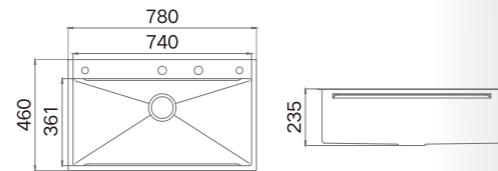

Information

Product Dimension (LxWxD)	780x460x235mm
Material	SUS304
Thickness	2.5+0.8mm
Corner	Radius 10
Cutout Size (Topmount)	760mmx440mm (R0)
Cutout Size (Undermount)	743x431mm (R10)

Standard Accessories



984223C

ART.NO. **952358**

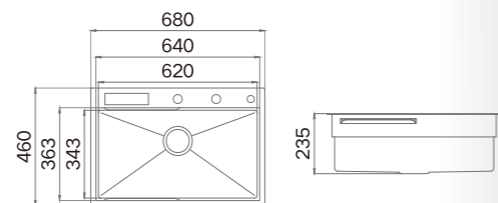

Information

Product Dimension (LxWxD)	680x460x235mm
Material	SUS304
Thickness	2.5+0.8mm
Corner	Radius 10
Cutout Size (Topmount)	660mmx440mm (R0)
Cutout Size (Undermount)	643x433mm (R0)

Standard Accessories



984223C



983130



986007

ART.NO. **952361**

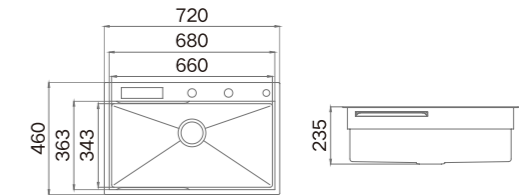

Information

Product Dimension (LxWxD)	720x460x235mm
Material	SUS304
Thickness	2.5+0.8mm
Corner	Radius 10
Cutout Size (Topmount)	700x440mm (R0)
Cutout Size (Undermount)	683x433mm (R0)

Standard Accessories



984223C



983130



986007

ART.NO. **952364**

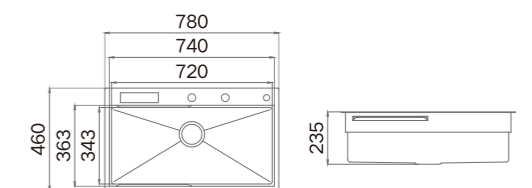

Information

Product Dimension (LxWxD)	780x460x235mm
Material	SUS304
Thickness	2.5+0.8mm
Corner	Radius 10
Cutout Size (Topmount)	760x440mm (R0)
Cutout Size (Undermount)	743x433mm (R0)

Standard Accessories



984223C



983130



986007

BL1.0 OS SERIES SINKS

Design Patent No. : 202330239713.3

Take the stone as a guide, Change it to harder surface. Re-engage the natural texture of stone on the sink. Explode amazing wear resistance

BL1.0 OS SERIES SINKS

Through high-tech embossing technology, the tightly embossed grain surface attached to the body, improving the hardness of the sink to resist the deformation during daily scratches.

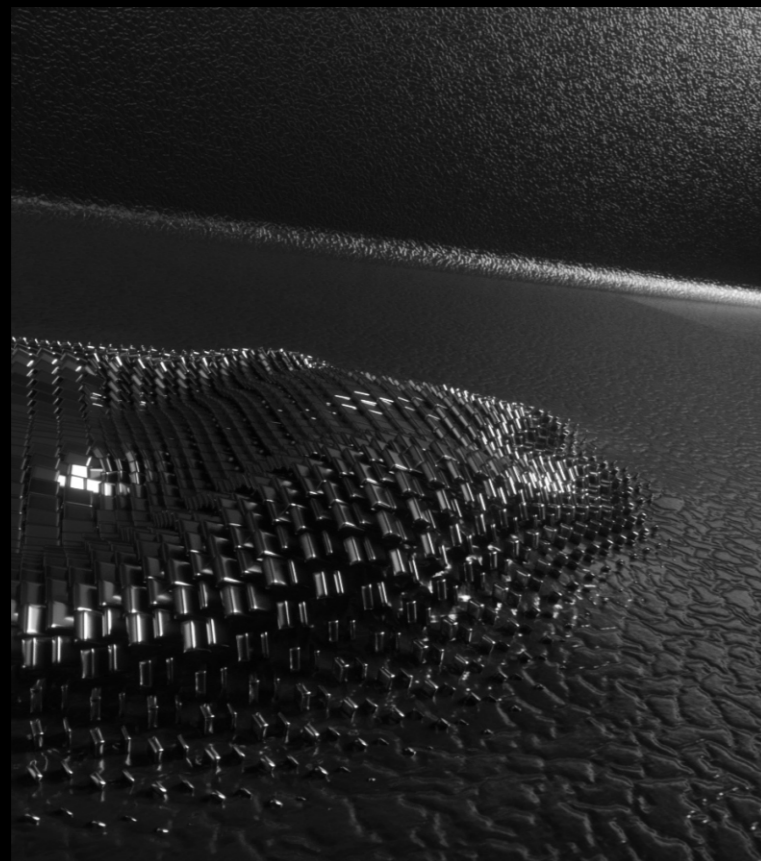

ART.NO. **952435**

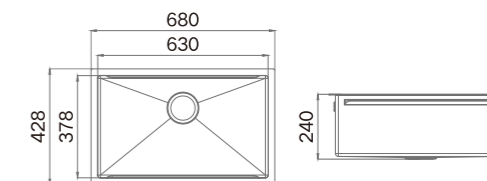

Information

Product Dimension (LxWxD)	680x428x240mm
Material	SUS304
Thickness	2.5+1.0mm
Corner	Radius 10
Cutout Size (Topmount)	660x408mm (R0)
Cutout Size (Undermount)	633x381mm (R12)

Standard Accessories



984170 983118 984189

ART.NO. **952438**

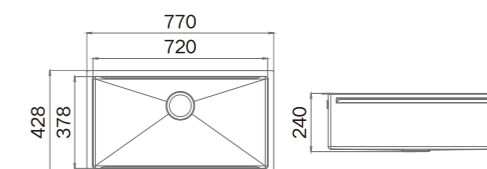

Information

Product Dimension (LxWxD)	770x428x240mm
Material	SUS304
Thickness	2.5+1.0mm
Corner	Radius 10
Cutout Size (Topmount)	750x408mm (R0)
Cutout Size (Undermount)	723x381mm (R12)

Standard Accessories



984170 983118 984189

ART.NO. **952441**

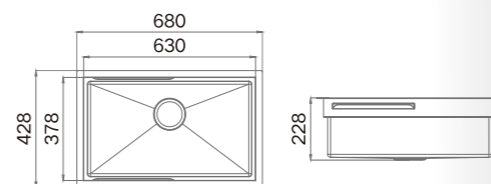

Information

Product Dimension (LxWxD) 680x428x228mm
 Material SUS304
 Thickness 2.5+1.0mm
 Corner Radius 10
 Cutout Size (Topmount) 660x408mm (R0)
 Cutout Size (Undermount) 633x381mm (R0)

Standard Accessories



ART.NO. **952444**

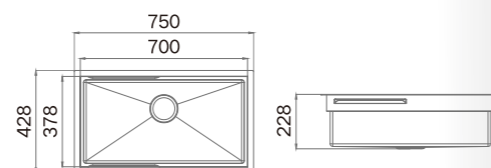

Information

Product Dimension (LxWxD) 750x428x228mm
 Material SUS304
 Thickness 2.5+1.0mm
 Corner Radius 10
 Cutout Size (Topmount) 750x408mm (R0)
 Cutout Size (Undermount) 723x381mm (R0)

Standard Accessories



ART.NO. **952447**

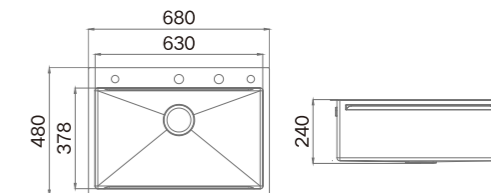

Information

Product Dimension (LxWxD) 680x480x240mm
 Material SUS304
 Thickness 3.0+1.0mm
 Corner Radius 10
 Cutout Size (Topmount) 660x460mm (R0)
 Cutout Size (Undermount) 633x449mm (R12)

Standard Accessories



ART.NO. **952450**

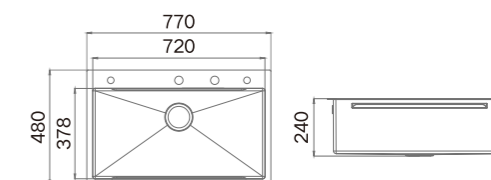

Information

Product Dimension (LxWxD) 770x480x240mm
 Material SUS304
 Thickness 3.0+1.0mm
 Corner Radius 10
 Cutout Size (Topmount) 750x460mm (R0)
 Cutout Size (Undermount) 723x449mm (R12)

Standard Accessories



ART.NO. **952453**

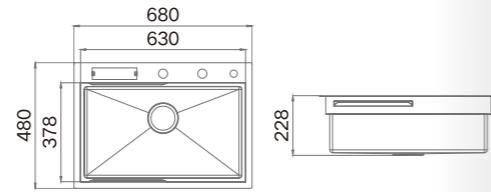

Information

Product Dimension (LxWxD)	680x480x228mm
Material	SUS304
Thickness	3.0+1.0mm
Corner	Radius 10
Cutout Size (Topmount)	660x460mm (R0)
Cutout Size (Undermount)	633x449mm (R0)

Standard Accessories



ART.NO. **952459**

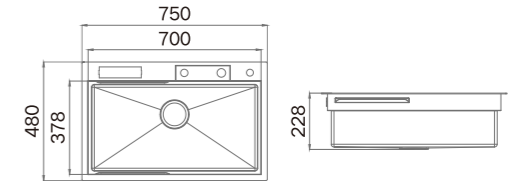

Information

Product Dimension (LxWxD)	750x480x228mm
Material	SUS304
Thickness	3.0+1.0mm
Corner	Radius 10
Cutout Size (Topmount)	730x460mm (R0)
Cutout Size (Undermount)	703x449mm (R0)

Standard Accessories



ART.NO. **952456**

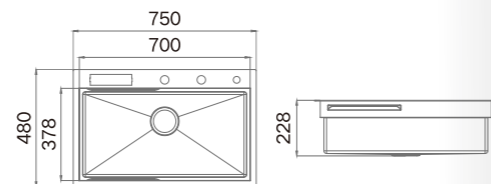

Information

Product Dimension (LxWxD)	750x480x228mm
Material	SUS304
Thickness	3.0+1.0mm
Corner	Radius 10
Cutout Size (Topmount)	730x460mm (R0)
Cutout Size (Undermount)	703x449mm (R0)

Standard Accessories



KITCHEN CHANNEL SINKS

Free Configuration to Customize your preference

Multiple accessories can be taken out separately, Free to adjust the allocation based on your habit



ART.NO. 962045



● Black ● Gold ● Rosy

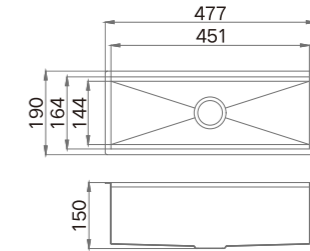

Information

Product Dimension (LxWxD)	477x190x150mm
Material	SUS304
Thickness	1.0mm
Corner	Radius 0
Cutout Size (Topmount)	461x174mm
Cutout Size (Undermount)	454x167mm

Description

Brushed surface;
Workstation channel sink;
Accessories can be taken out separately, free to adjust the allocation;

ART.NO. 962046



● Black ● Gold ● Rosy

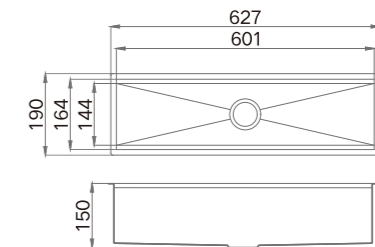

Information

Product Dimension (LxWxD)	627x190x150mm
Material	SUS304
Thickness	1.0mm
Corner	Radius 0
Cutout Size (Topmount)	611x174mm
Cutout Size (Undermount)	604x167mm

Description

Brushed surface;
Workstation channel sink;
Accessories can be taken out separately, free to adjust the allocation;

ART.NO. **962047**

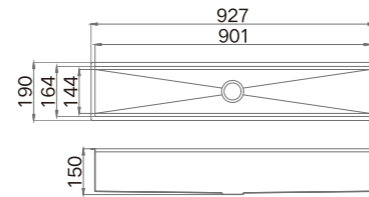

Information

Product Dimension (LxWxD)	927x190x150mm
Material	SUS304
Thickness	1.0mm
Corner	Radius 0
Cutout Size (Topmount)	911x174mm
Cutout Size (Undermount)	904x167mm

Description

Brushed surface;
Workstation channel sink;
Accessories can be taken out separately,
free to adjust the allocation;

ART.NO. **962053**

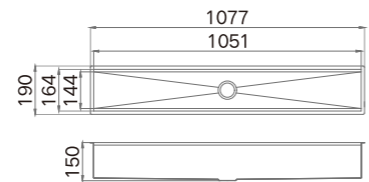

Information

Product Dimension (LxWxD)	1077x190x150mm
Material	SUS304
Thickness	1.0mm
Corner	Radius 0
Cutout Size (Topmount)	1061x174mm
Cutout Size (Undermount)	1054x167mm

Description

Brushed surface;
Workstation channel sink;
Accessories can be taken out separately,
free to adjust the allocation;

ART.NO. **962059**

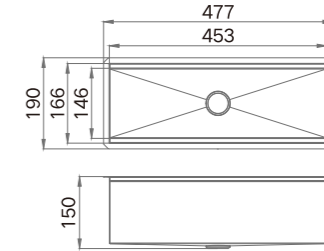

Information

Product Dimension (LxWxD)	477x190x150mm
Material	SUS304
Thickness	1.0mm
Corner	Radius 0
Cutout Size (Topmount)	461x174mm
Cutout Size (Undermount)	454x167mm

Description

Brushed surface;
Workstation channel sink;
Accessories can be taken out separately,
free to adjust the allocation;

ART.NO. **962060**

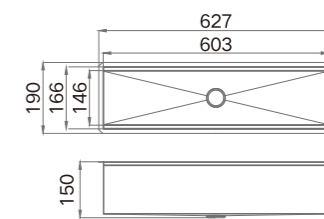

Information

Product Dimension (LxWxD)	627x190x150mm
Material	SUS304
Thickness	1.0mm
Corner	Radius 0
Cutout Size (Topmount)	611x174mm
Cutout Size (Undermount)	604x167mm

Description

Brushed surface;
Workstation channel sink;
Accessories can be taken out separately,
free to adjust the allocation;

ART.NO. **962061**

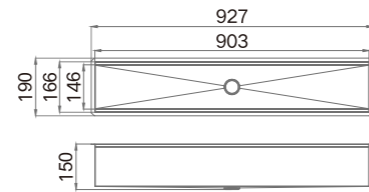

● Black ● Gold ● Rosy

Information

Product Dimension (LxWxD)	927x190x150mm
Material	SUS304
Thickness	1.0mm
Corner	Radius 0
Cutout Size (Topmount)	911x174mm
Cutout Size (Undermount)	904x167mm

Description

Brushed surface;
Workstation channel sink;
Accessories can be taken out separately,
free to adjust the allocation;

ART.NO. **962062**

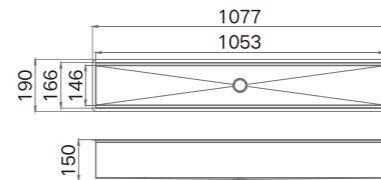
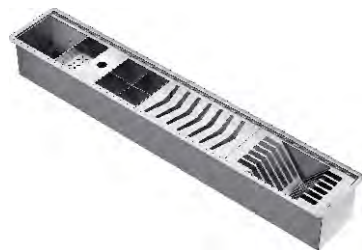

● Black ● Gold ● Rosy

Information

Product Dimension (LxWxD)	1077x190x150mm
Material	SUS304
Thickness	1.0mm
Corner	Radius 0
Cutout Size (Topmount)	1061x174mm
Cutout Size (Undermount)	1054x167mm

Description

Brushed surface;
Workstation channel sink;
Accessories can be taken out separately,
free to adjust the allocation;

ART.NO. **962054**

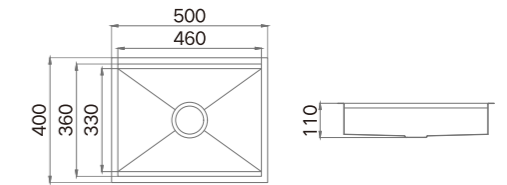

● Black ● Gold ● Rosy

Information

Product Dimension (LxWxD)	500x400x110mm
Material	SUS304
Thickness	1.0mm
Corner	Radius 0
Cutout Size (Topmount)	480x384mm
Cutout Size (Undermount)	463x363mm

Description

Brushed surface;
Workstation channel sink;
Accessories can be taken out separately,
free to adjust the allocation;

ART.NO. **984175**

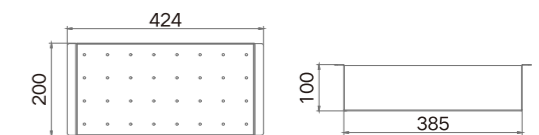

● Black ● Gold ● Rosy

Information

Product Dimension (LxWxD)	424x200x100mm
Material	SUS304
Thickness	1.0mm
Corner	Radius 0

Description

Brushed surface;
Draining accessories;
Accessories can be taken out separately,
free to adjust the allocation;

INTELLIGENT PURIFICATION SINKS

Purification sink is a great product of smart idea and new technology.
Higold is not only the leading company in this area,
but also one of the companies who draft the production
standard of this kind of product .





4 steps of physical purification Eliminate pathogenic factors in depth



Hydrolysis

OH self-purification factors are generated by electrolysis water molecules

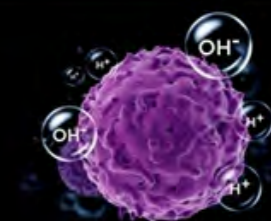

Purification

OH self-purification factors decompose the toxic and hazardous substances by oxygenolysis



Restoration

After purification OH self-purification factors re-combine and restore into water

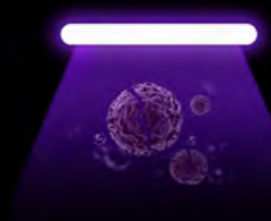

Sterilization

UV ray shoots bacteria and viruses to achieve disinfection and sterilization

ART.NO. **973012**

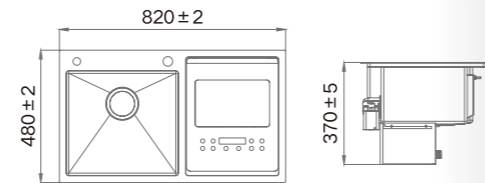

Information

Product Dimension (LxWxD)	820x480x370mm
Material	SUS304
Thickness	3+1.2mm
Corner	Radius 10
Bowl Size	380x405+310x310mm
Cutout Size (Topmount)	800x460mm (R10)

Description

Brushed surface;
Double bowl;
With sound pad and undercoating;
With 2" soft pipe drainage;

ART.NO. **973013**

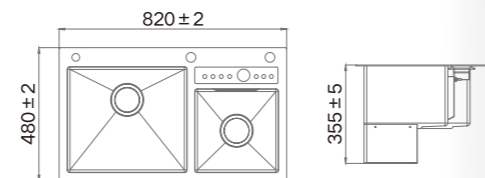

Information

Product Dimension (LxWxD)	820x480x355mm
Material	SUS304
Thickness	3+1.2mm
Corner	Radius 10
Bowl Size	430x380+300x300mm
Cutout Size (Topmount)	800x460mm (R10)

Description

Brushed surface;
Pure nano treatment;
Double bowl;
With sound pad and undercoating;
With 2" soft pipe table-control drainage;

ART.NO. **973014**

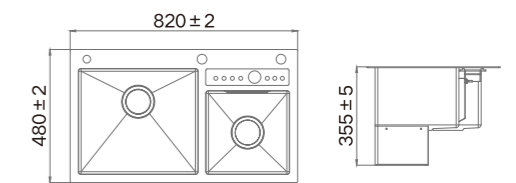

Information

Product Dimension (LxWxD)	820x480x355mm
Material	SUS304
Thickness	3+1.2mm
Corner	Radius 10
Bowl Size	430x380+300x300mm
Cutout Size (Topmount)	800x460mm (R10)

Description

Brushed surface;
Double bowl;
With sound pad and undercoating;
With 2" soft pipe table-control drainage;

ART.NO. **973015**

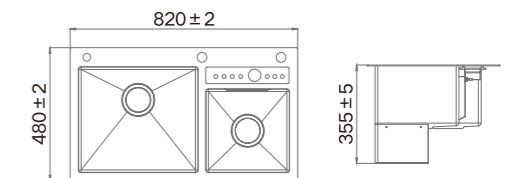

Information

Product Dimension (LxWxD)	820x480x355mm
Material	SUS304
Thickness	3+1.2mm
Corner	Radius 10
Bowl Size	430x380+300x300mm
Cutout Size (Topmount)	800x460mm (R10)

Description

Brushed surface;
PVD Matt black;
Double bowl;
With sound pad and undercoating;
With 2" soft pipe table-control drainage;

PRESSING SINKS

artistic-looking, beautiful curve and the unique sense of integration ...
easy to handle, energy saving and cost efficient.
R20 sinks have square looks like handmade sinks, but cost much less.



ART.NO. **920218**

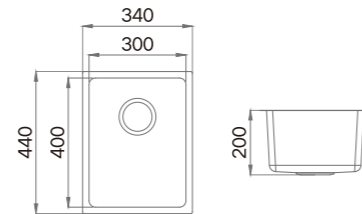

Information

Product Dimension (LxWxD)	340x440x200mm
Material	SUS304
Thickness	0.9mm
Corner	Radius 20
Cutout Size (Topmount)	320x420mm (R0)
Cutout Size (Undermount)	303x403mm (R20)

Description

Brushed surface;
Single bowl;
With sound pad and undercoating;
Optional accessories:
Drainer, Colander, Chopping board, Grid,
Rollmat, Wire basket.

ART.NO. **920220**

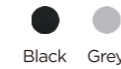
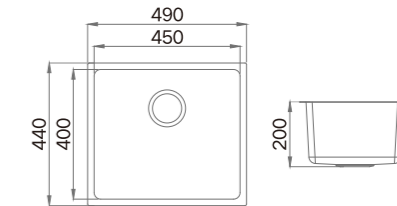

Information

Product Dimension (LxWxD)	490x440x200mm
Material	SUS304
Thickness	0.9mm
Corner	Radius 20
Cutout Size (Topmount)	470x420mm (R0)
Cutout Size (Undermount)	453x403mm (R20)

Description

Brushed surface;
Single bowl;
With sound pad and undercoating;
Optional accessories:
Drainer, Colander, Chopping board, Grid,
Rollmat, Wire basket.

ART.NO. **920219**

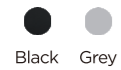
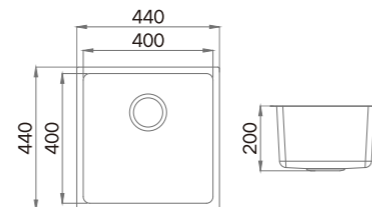

Information

Product Dimension (LxWxD)	440x440x200mm
Material	SUS304
Thickness	0.9mm
Corner	Radius 20
Cutout Size (Topmount)	420x420mm (R0)
Cutout Size (Undermount)	403x403mm (R20)

Description

Brushed surface;
Single bowl;
With sound pad and undercoating;
Optional accessories:
Drainer, Colander, Chopping board, Grid,
Rollmat, Wire basket.

ART.NO. **920221**

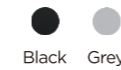
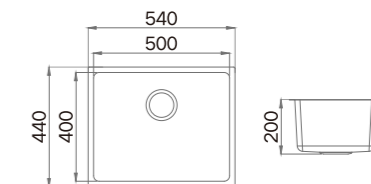

Information

Product Dimension (LxWxD)	540x440x200mm
Material	SUS304
Thickness	0.9mm
Corner	Radius 20
Cutout Size (Topmount)	520x420mm (R0)
Cutout Size (Undermount)	503x403mm (R20)

Description

Brushed surface;
Single bowl;
With sound pad and undercoating;
Optional accessories:
Drainer, Colander, Chopping board, Grid,
Rollmat, Wire basket.

ART.NO. **920222**

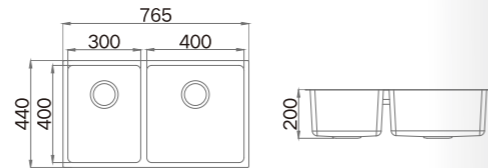

● Black ● Grey

Information

Product Dimension (LxWxD)	765x440x200mm
Material	SUS304
Thickness	0.9mm
Corner	Radius 20
Cutout Size (Topmount)	745x420mm (R0)
Cutout Size (Undermount)	728x403mm (R20)

Description

Brushed surface;
 Double bowl;
 With sound pad and undercoating;
 Optional accessories:
 Drainer, Colander, Chopping board, Grid,
 Rollmat, Wire basket.

ART.NO. **920223**

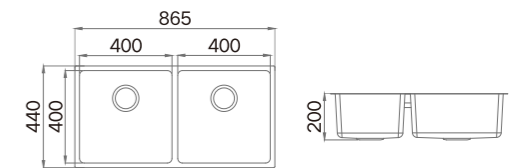

● Black ● Grey

Information

Product Dimension (LxWxD)	865x440x200mm
Material	SUS304
Thickness	0.9mm
Corner	Radius 20
Cutout Size (Topmount)	845x420mm (R0)
Cutout Size (Undermount)	828x403mm (R20)

Description

Brushed surface;
 Double bowl;
 With sound pad and undercoating;
 Optional accessories:
 Drainer, Colander, Chopping board, Grid,
 Rollmat, Wire basket.

ART.NO. **920228**

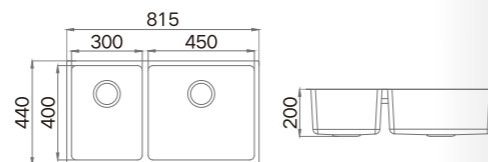

● Black ● Grey

Information

Product Dimension (LxWxD)	815x440x200mm
Material	SUS304
Thickness	0.9mm
Corner	Radius 20
Cutout Size (Topmount)	795x420mm (R0)
Cutout Size (Undermount)	778x403mm (R20)

Description

Brushed surface;
 Double bowl;
 With sound pad and undercoating;
 Optional accessories:
 Drainer, Colander, Chopping board, Grid,
 Rollmat, Wire basket.

BL2.0 SERIES SINK

Simplify complexity, outline modern aesthetics with simple lines, and integrate multiple kitchen tasks in a square inch space. Simple but not reduced, stainless steel combined with nano-coating, solid material and excellent surface treatment, play well and use wonderfully.





ART.NO. **920255**

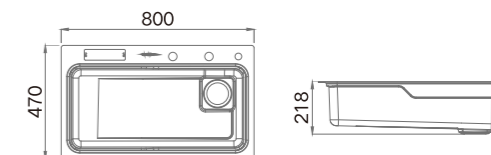

Information

Product Dimension (LxWxD)	800x470x218mm
Material	SUS304
Thickness	3+0.9mm
Color	Nano Grey
Cutout Size (Topmount)	780x450mm (R15)
Cutout Size (Undermount)	755x438mm (R50)

Standard Accessories



ART.NO. **920244**

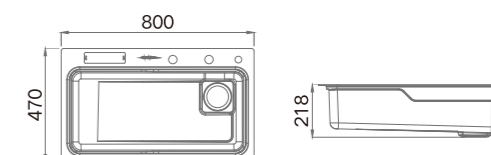

Information

Product Dimension (LxWxD)	800x470x218mm
Material	SUS304
Thickness	3+0.9mm
Color	PVD Matt Black
Cutout Size (Topmount)	780x450mm (R15)
Cutout Size (Undermount)	755x438mm (R50)

Standard Accessories



ANGAS SINKS

Angas nano pressing sink

Show ingenuity in subtle details, Endow life a wonderful sense of order



ART.NO. **920266**

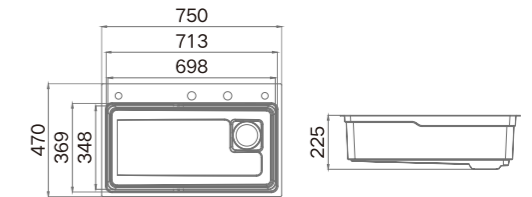

Information

Product Dimension (LxWxD)	750x470x225mm
Material	SUS304
Thickness	3+0.8mm
Color	Nano Grey
Cutout Size (Topmount)	730x450mm (R15)
Cutout Size (Undermount)	725x450mm (R25)

Standard Accessories

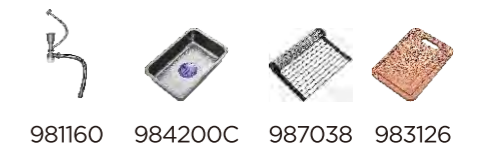

ART.NO. **920267**

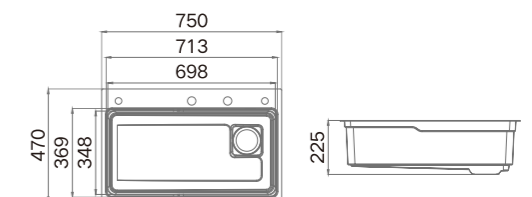

Information

Product Dimension (LxWxD)	750x470x225mm
Material	SUS304
Thickness	3+0.8mm
Color	PVD Matt Black
Cutout Size (Topmount)	730x450mm (R15)
Cutout Size (Undermount)	725x450mm (R25)

Standard Accessories

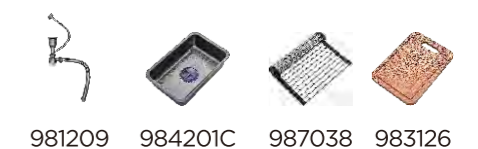

BL3.0 SERIES SINK

All-round upgrade, more than clean

Follow the nature, Incarnate as a flash inspired from the celestial meteor, Cut through the sky in an instant
Condensed instant streamer into a lasting work



ART.NO. **920286**

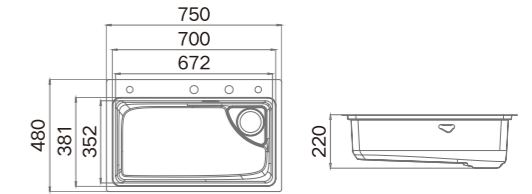

Information

Product Dimension (LxWxD)	750x480x220mm
Material	SUS304
Thickness	3+0.9mm
Color	PVD Matt Black
Cutout Size (Topmount)	730x460mm (R15)
Cutout Size (Undermount)	713x457mm (R40)

Standard Accessories



ART.NO. **920287**

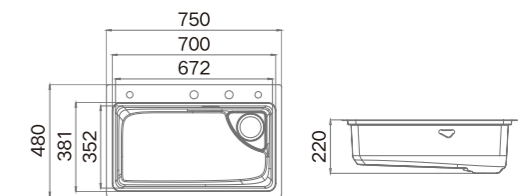

Information

Product Dimension (LxWxD)	750x480x220mm
Material	SUS304
Thickness	3+0.9mm
Color	Nano Grey
Cutout Size (Topmount)	730x460mm (R15)
Cutout Size (Undermount)	713x457mm (R40)

Standard Accessories





KW SERIES KITCHEN SINK

All food comes from the strict selection and careful cooking of ingredients. Similarly, in product design, material selection and production, we focus on each link.

KITCHEN SINK

The Higold stretch sink is made of 304 stainless steel, which is integrally formed under gravity stamping. The sturdy and durable grooves are made with ingenuity.



ART.NO. **920243**

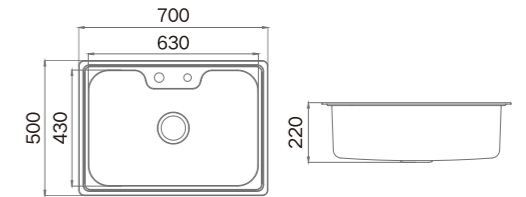

Information

Product Dimension (LxWxD)	700x500x220mm
Material	SUS304
Thickness	0.75mm
Cutout Size (Topmount)	680x480mm (R15)
Cutout Size (Undermount)	675x475mm (R25)

Description

Brushed surface;
Single bowl;
With sound pad and undercoating;
Optional accessories:
Drainer, Chopping board, Soap dispenser,
Wire basket.

ART.NO. **920290**

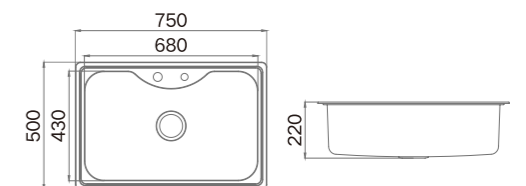

Information

Product Dimension (LxWxD)	750x500x220mm
Material	SUS304
Thickness	0.8mm
Cutout Size (Topmount)	730x480mm (R15)
Cutout Size (Undermount)	725x475mm (R25)

Description

Brushed surface;
Single bowl;
With sound pad and undercoating;
Optional accessories:
Drainer, Chopping board, Soap dispenser,
Wire basket.

ART.NO. **920291**

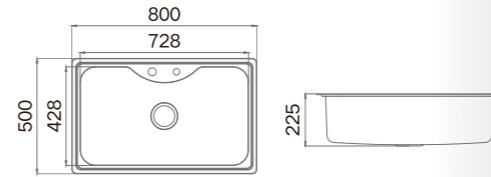

Information

Product Dimension (LxWxD)	800x500x225mm
Material	SUS304
Thickness	0.8mm
Cutout Size (Topmount)	780x480mm (R15)
Cutout Size (Undermount)	775x475mm (R25)

Description

Brushed surface;
Single bowl;
With sound pad and undercoating;
Optional accessories:
Drainer, Chopping board, Soap dispenser,
Wire basket.

ART.NO. **920200**

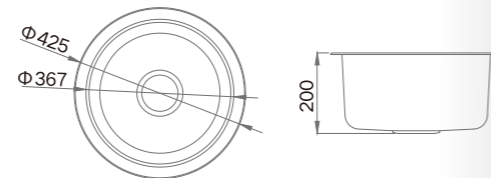

Information

Product Dimension (LxWxD)	Φ425x200mm
Material	SUS304
Thickness	0.72mm
Cutout Size (Topmount)	Φ405mm
Cutout Size (Undermount)	Φ390mm

Description

Brushed surface;
Round bowl;
With sound pad and undercoating;
Optional accessories:
Drainer, Colander, Chopping board.

ART.NO. **920288**

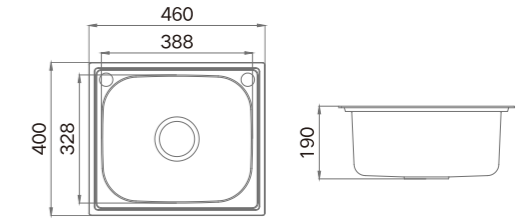

Information

Product Dimension (LxWxD)	460x400x190mm
Material	SUS304
Thickness	0.8mm
Cutout Size (Topmount)	440x380mm (R15)
Cutout Size (Undermount)	440x380mm (R15)

Description

Brushed surface;
Single bowl;
With sound pad and undercoating;
Optional accessories:
Drainer, colander, chopping board,
Soap dispenser, Wire basket.

ART.NO. **920289**

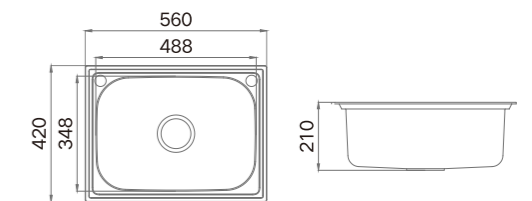

Information

Product Dimension (LxWxD)	560x420x210mm
Material	SUS304
Thickness	0.8mm
Cutout Size (Topmount)	540x400mm (R5)
Cutout Size (Undermount)	540x400mm (R5)

Description

Brushed surface;
Single bowl;
With sound pad and undercoating;
Optional accessories:
Drainer, colander, chopping board,
Soap dispenser, Wire basket.

ART.NO. **920150**

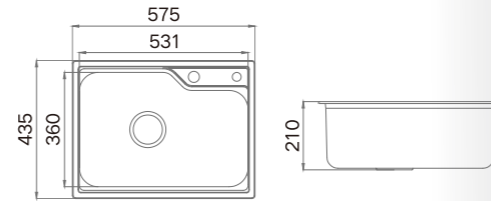

Information

Product Dimension (LxWxD)	575x435x210mm
Material	SUS304
Thickness	0.7mm
Cutout Size (Topmount)	550x410mm (R8)
Cutout Size (Undermount)	542x400mm (R8)

Description

Brushed surface;
Single bowl;
With sound pad and undercoating;
Optional accessories:
Drainer, colander, chopping board,
Soap dispenser, Wire basket.

ART.NO. **920039**

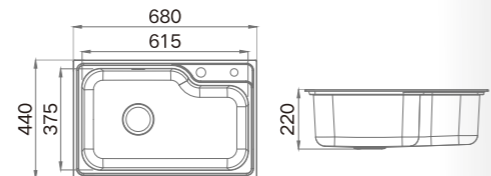

Information

Product Dimension (LxWxD)	680x440x220mm
Material	SUS304
Thickness	0.7mm
Cutout Size (Topmount)	660x420mm (R15)
Cutout Size (Undermount)	662x422mm (R25)

Description

Brushed surface / Nano coating;
Single bowl;
With sound pad and undercoating;
Optional accessories:
Drainer, colander, chopping board,
Soap dispenser, Wire basket.

ART.NO. **920006**

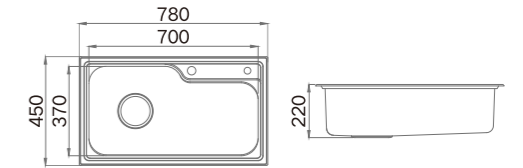

Information

Product Dimension (LxWxD)	780x450x220mm
Material	SUS304
Thickness	0.8mm
Cutout Size (Topmount)	750x420mm (R25)
Cutout Size (Undermount)	740x410mm (R25)

Description

Brushed surface / Nano coating;
Single bowl;
With sound pad and undercoating;
Optional accessories:
Drainer, colander, chopping board,
Soap dispenser, Wire basket.

ART.NO. **920292**

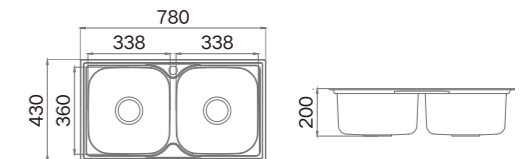

Information

Product Dimension (LxWxD)	780x430x200mm
Material	SUS304
Thickness	0.7mm
Cutout Size (Topmount)	760x410mm (R5)
Cutout Size (Undermount)	760x410mm (R10)

Description

Brushed surface;
Double bowl;
With sound pad and undercoating;
Optional accessories:
Drainer, colander, chopping board,
Soap dispenser, Wire basket.

ART.NO. **920293**

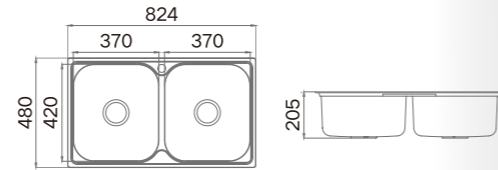

Information

Product Dimension (LxWxD)	824x480x205mm
Material	SUS304
Thickness	0.7mm
Cutout Size (Topmount)	804x460mm (R15)
Cutout Size (Undermount)	801x457mm (R25)

Description

Brushed surface;
 Double bowl;
 With sound pad and undercoating;
 Optional accessories:
 Drainer, colander, chopping board,
 Soap dispenser, Wire basket.

ART.NO. **920294**

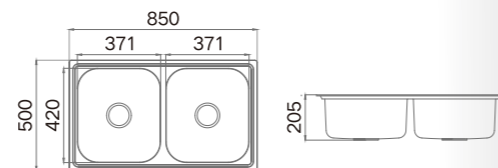

Information

Product Dimension (LxWxD)	850x500x205mm
Material	SUS304
Thickness	0.7mm
Cutout Size (Topmount)	830x480mm (R15)
Cutout Size (Undermount)	824x474mm (R30)

Description

Brushed surface;
 Double bowl;
 With sound pad and undercoating;
 Optional accessories:
 Drainer, colander, chopping board,
 Soap dispenser, Wire basket.

ART.NO. **920295**

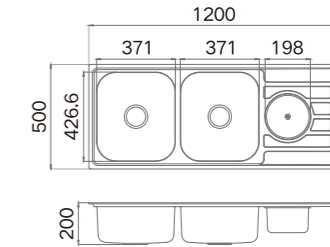

Information

Product Dimension (LxWxD)	1200x500x200mm
Material	SUS304
Thickness	0.7mm
Cutout Size (Topmount)	1180x480mm (R15)
Cutout Size (Undermount)	1172x472mm (R25)

Description

Brushed surface;
 Double bowl with trash can;
 With sound pad and undercoating;
 Optional accessories:
 Drainer, colander, chopping board,
 Soap dispenser, Wire basket.

BN1.0 SERIES KITCHEN FAUCETS

Patent NO. : ZL201930671366.5



Fashion Design style break the traditional pattern,
design a new idea, full of fashion style. make elegant
space, ignite a modern luster.





BN1.0 SERIES KITCHEN FAUCET



NO. 980128
Rose Gold+Black



NO. 980129
Brushed PVD



NO. 980157
Grey

Model No.	Color	Size (mm)	Material
980128	Rose Gold+Black	425x175	Zinc + SS outlet pipe
980129	Brushed PVD	425x175	SUS304
980157	Grey	425x175	SUS304

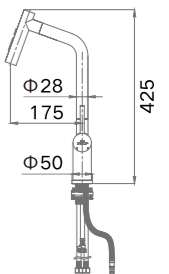

ROMANTIC GENE RISING STAR OF ART

Coming across from the Atlantic Ocean
With romantic atmosphere of an exotic scenery
Delicate representative
New rising star of art



BN2.0 SERIES KITCHEN FAUCET

Patent NO.: ZL202130448002.8



NO. 980209
Rose Gold+Black



NO. 980207
Brushed Nickel PVD



NO. 980208
Grey

Model No.	Color	Size (mm)	Material
980209	Rose Gold+Black	540x210	Zinc + Brass
980207	Brushed Nickel PVD	540x210	Zinc + SUS304
980208	Grey	540x210	Zinc + Brass

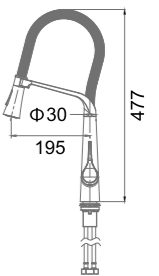

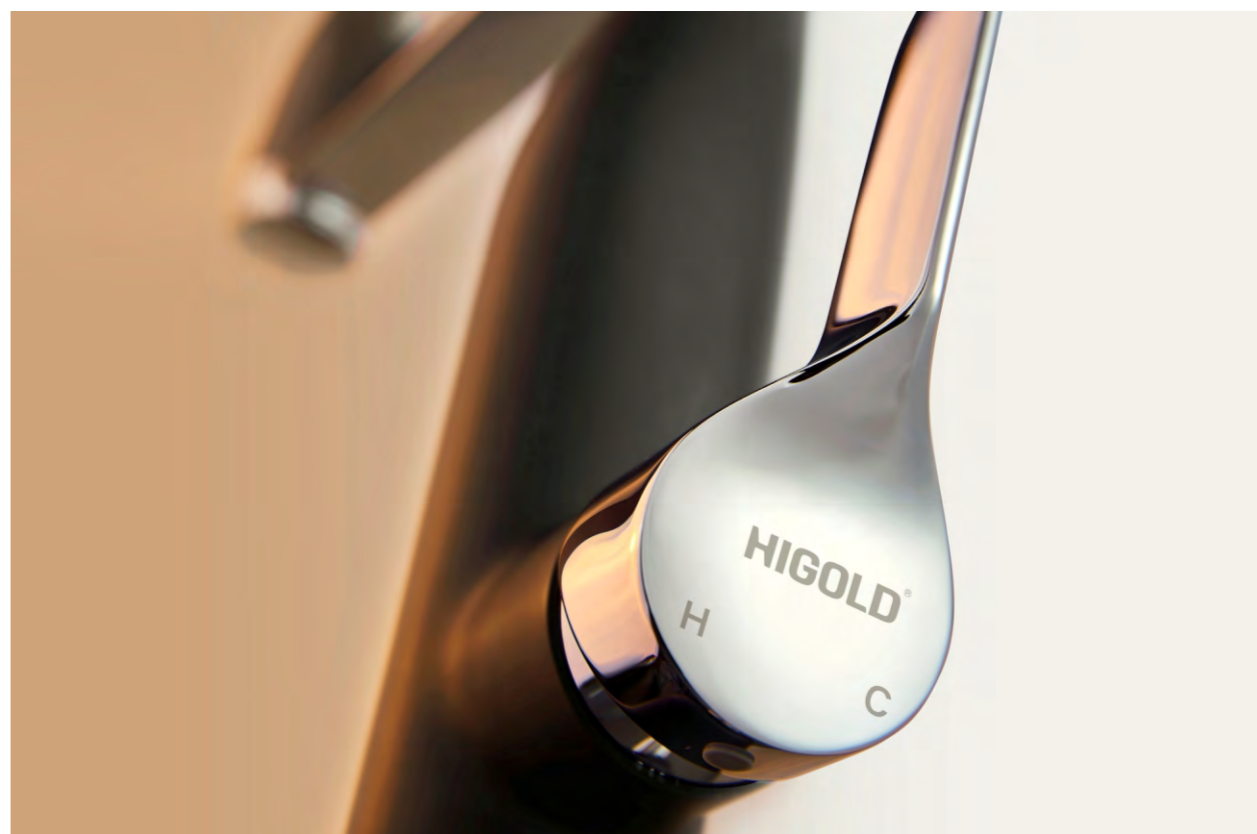

BN3.0 SERIES KITCHEN FAUCET



NO. 980138
Chrome



NO. 980172
Electrophoresis Black



NO. 980173
PVD grey color



NO. 980174
White

Model No.	Color	Size (mm)	Material
980138	Chrome	537x210	Zinc + Brass
980172	Electrophoresis Black	537x210	Zinc + Brass
980173	PVD grey color	537x210	Zinc + Brass
980174	White	537x210	Zinc + Brass

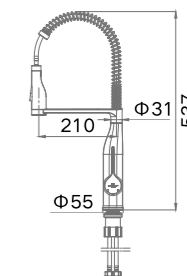



BN4.0 SERIES KITCHEN FAUCET



NO. 980175
Rose Gold+Black



NO. 980176
SS Brushed



NO. 980177
PVD Grey

Model No.	Color	Size (mm)	Material
980175	Rose Gold+Black	370x175	SUS304
980176	SS Brushed	370x175	SUS304
980177	PVD Grey	370x175	SUS304

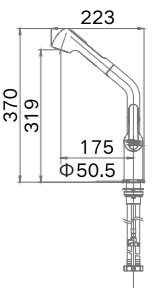



WATERFALL KITCHEN FAUCET

Three-in-one, Integrated washing. Natural water flow design, The water outlet holes are distributed laterally and densely. Abundant water, wash at will.



Model No.	980194
Color	Grey
Size (mm)	428x246
Material	SUS304

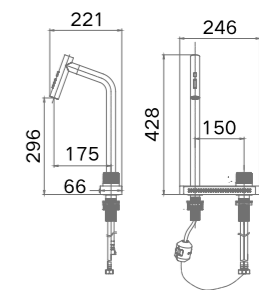

KITCHEN FAUCET



ITEM NO. 980191

Product Size: 420x210mm;
 Color: PVD Gun Grey + Brushed Gold;
 Material: Brass + SUS304;
 cold / hot water
 Pull-out hose + waterfall outlet
 Topmount

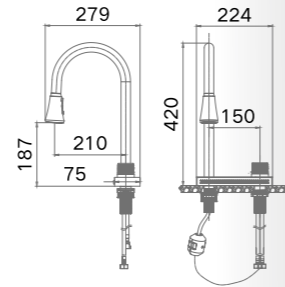

ITEM NO. 980091

Product Size: 240x350mm;
 Brushed SUS304 Stainless Steel;
 cold / hot water;
 Pull-out hose

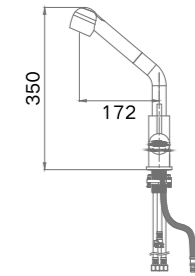

ITEM NO. 980104

(Universal Joint)
 Product Size: 190x337mm;
 Brushed SUS304 Stainless Steel;
 cold / hot water

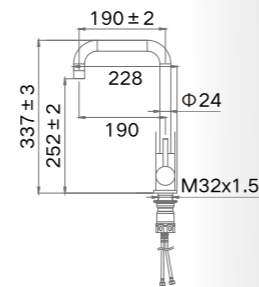

ITEM NO. 980096

Product Size: 230x630mm;
 Brushed SUS304 Stainless Steel;
 cold / hot water

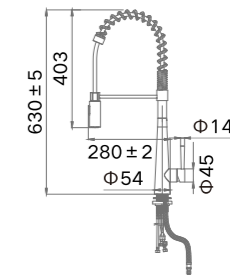

ITEM NO. 980106

(Universal Joint)
 Product Size: 205x378mm;
 Brushed SUS304 Stainless Steel;
 cold / hot water

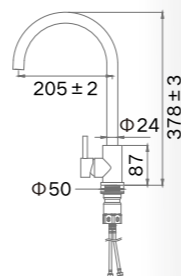

ITEM NO. 980099

Product Size: 239x415mm;
 Brushed SUS304 Stainless Steel;
 cold / hot water;
 Pull-out hose

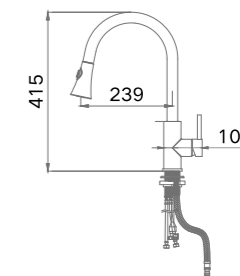



ACCESSORIES - WATER DRAINAGE



ITEM NO. 981001
Drainer head (1.5")
+ Hard Pipe
For single bowl



ITEM NO. 981003
Drainer head (1.5")
+ Hard Pipe
For double bowl



ITEM NO. 981002
Drainer head (2")
+ Soft Pipe
For single bowl



ITEM NO. 981004
Drainer head (2")
+ Soft Pipe
For double bowl



ITEM NO. 981156
Drainer head (2")
+ Soft Pipe
For single bowl



ITEM NO. 981157
Drainer head (2")
+ Soft Pipe
For double bowl



ITEM NO. 981001-403
Drainer head (1.5") with
overflow pipe

ACCESSORIES - DRAINER



ITEM NO. 981114
Drainer head (1.5")



ITEM NO. 981321-1000
Drainer head (1.5")



ITEM NO. 981158
Drainer head (1.5")

ACCESSORIES - GRID & COLANDER



ITEM NO. 982001
Wire basket

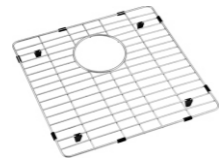

ITEM NO. 982251
Bottom Grid
(size adjustable)

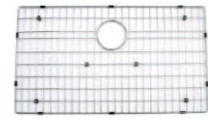

ITEM NO. 982170
Bottom Grid
(size adjustable)



ITEM NO. 984151
Extending Colander
Black



ITEM NO. 984190
Stainless steel colander
(size adjustable)



ITEM NO. 984223C
Stainless Steel Basin
(size fixed)

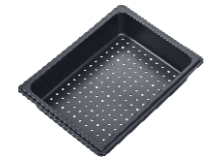

ITEM NO. 984170
Stainless Steel Basin
(size fixed)



ITEM NO. 984205
Stainless Steel Basin
(size fixed)

ACCESSORIES - CHOPPING BOARD



ITEM NO. 983011
chopping board
Rubber Wood



ITEM NO. 983027
chopping board
Bamboo



ITEM NO. 983002
chopping board
Sapele



ITEM NO. 983044
chopping board
Sapele

ACCESSORIES - SOAP DISPENSER & ROLLMAT



ITEM NO. 985001
Soap Dispenser
Plastic bottle



ITEM NO. 985003
Soap Dispenser
Plastic bottle



ITEM NO. 987014
Square-bar Rollmat
(Size adjustable)

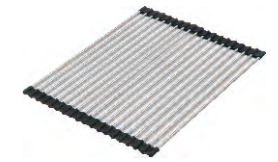

ITEM NO. 987017
Round-bar Rollmat
(Size adjustable)

INSTALLATION

Most of HIGOLD sinks apply to two typical installation style, Topmount and undermount and Flushmount, which require different clips and cutout sizes. Anyhow, they have one thing in common: Easy to Install.

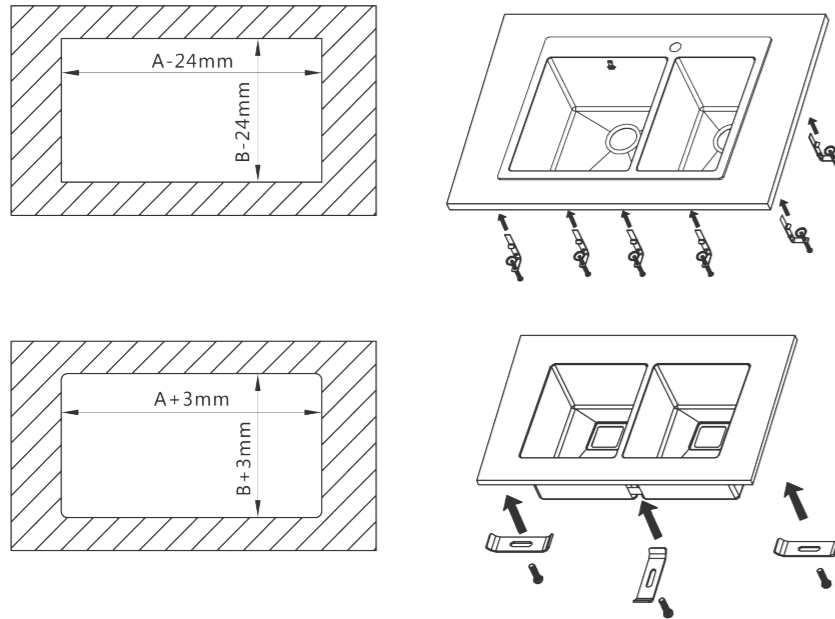

INSTALLATION METHOD

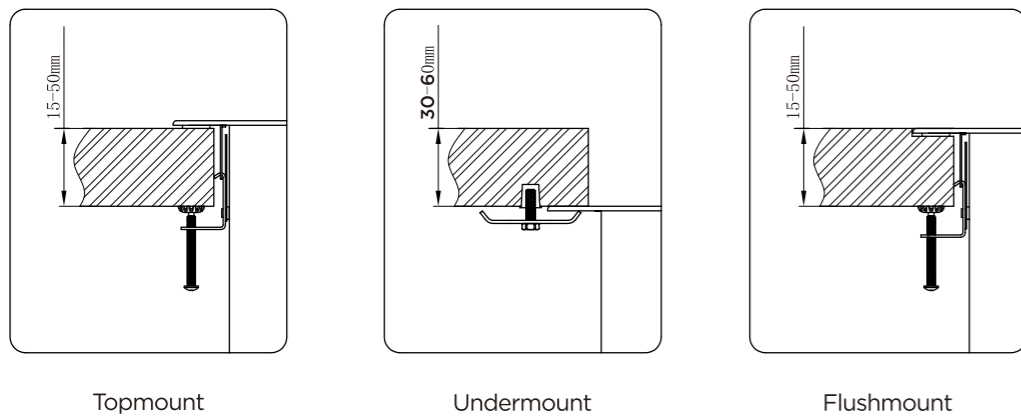

Topmount

Undermount

Flushmount

PACKAGE METHOD

Regular Packing Single carton

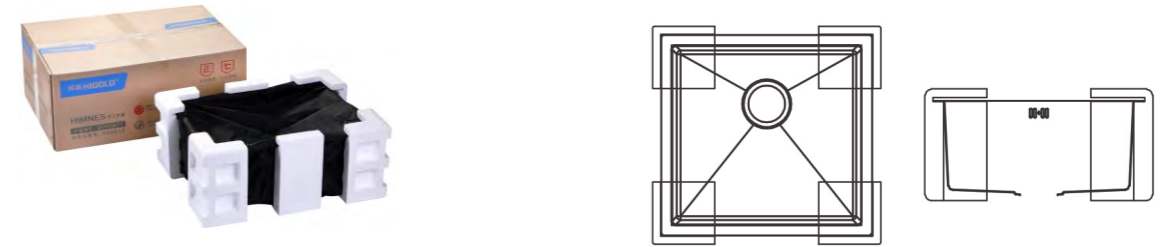

Item	901008 (product size: 508x483x228mm)
Carton qty.	1pc
20'	336pcs
40'	672pcs
40'HQ	756pcs
Remarks	Applicable for all types of sinks

Cost-Saving Packing Stacking Pallet

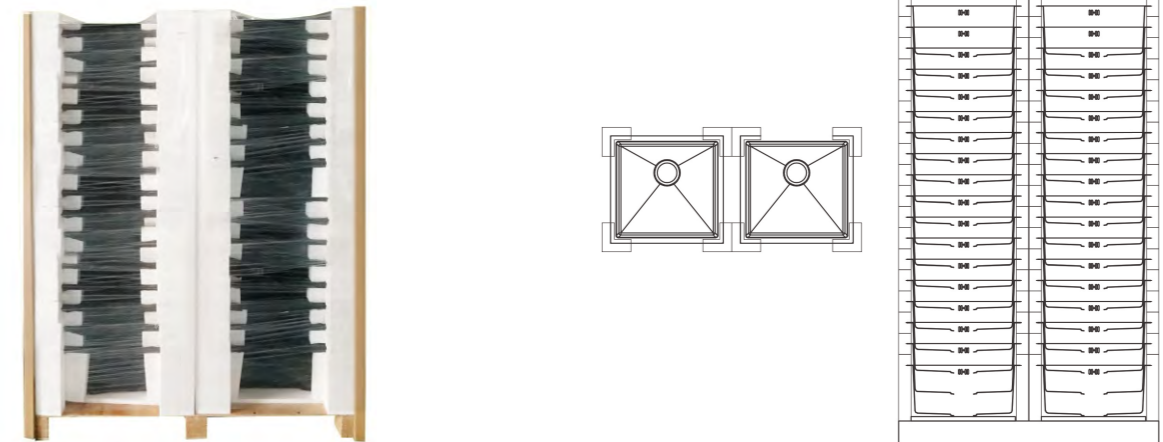

Item	901008 (product size: 508x483x228mm)
Pallet qty.	72pc
20'	648pcs
40'	1296pcs
40'HQ	1368pcs
Remarks	Not applicable for sinks with tray and apron sinks

BATHROOM SINKS

ART.NO. 617001A

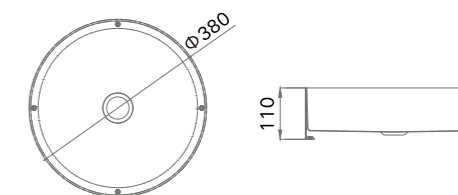

Information

Product Dimension	Φ380x110mm
Material	SUS304
Thickness	2.0+1.1mm
Cutout Size (Topmount)	Φ60mm

Description

Surface PVD Rose Gold;
Round bowl;
Standard assessories:
Bounce cap drainer, Corrugated pipe.

ART.NO. 617002A

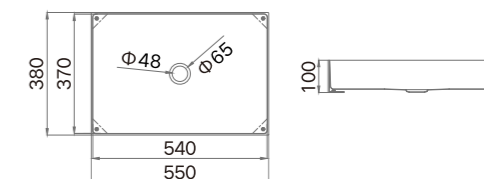

Information

Product Dimension (LxWxD)	550x380x100mm
Material	SUS304
Thickness	4.0+1.0mm
Cutout Size (Topmount)	730x480mm (R15)

Description

Surface PVD Black;
Single bowl;
Standard assessories:
Bounce cap drainer, Corrugated pipe.



B1 SERIES BASIN FAUCETS

pininfarina design

MINIMALIST ART GIVES PURE BEAUTY

Simple and smooth lines outline the shape of a tough building. When the combination of novel ingenuity and careful design, it creates a unique taste for the top of the basin.



B1 SERIES

B1 Series Hot And Cold Basin Faucet

ART.NO. 821300 / 821303

INFORMATION



821300

821303

SIZE	106x172x155mm 120x220x286mm	· Higold IP design · Streamline design
HOLE SIZE	Φ 35mm	· Hot and cold temperature control
MATERIAL	Low lead brass	· Ceramic cartridge
COLOR	Chrome	

ART.NO. 821301 / 821304

INFORMATION



821301

821304

SIZE	106x172x155mm 120x220x286mm	· Higold IP design · Streamline design
HOLE SIZE	Φ 35mm	· Hot and cold temperature control
MATERIAL	Low lead brass	· Ceramic cartridge
COLOR	Rosy Gold	

ART.NO. 821302 / 821305

INFORMATION



821302

821305

SIZE	106x172x155mm 120x220x286mm	· Higold IP design · Streamline design
HOLE SIZE	Φ 35mm	· Hot and cold temperature control
MATERIAL	Low lead brass	· Ceramic cartridge
COLOR	Gun Grey	



B2 SERIES

B2 Series Hot And Cold Basin Faucet

ART.NO. 821306 / 821309

INFORMATION



821306

821309

SIZE	45x180x154mm 45x226.5x287mm	· Higold IP design · Streamline design
HOLE SIZE	Φ 35mm	· Hot and cold temperature control
MATERIAL	Low lead brass	· Ceramic cartridge
COLOR	Chrome	

ART.NO. 821307 / 821310

INFORMATION



821307

821310

SIZE	45x180x154mm 45x226.5x287mm	· Higold IP design · Streamline design
HOLE SIZE	Φ 35mm	· Hot and cold temperature control
MATERIAL	Low lead brass	· Ceramic cartridge
COLOR	Gun Grey	

ART.NO. 821308 / 821311

INFORMATION



821308

821311

SIZE	45x180x154mm 45x226.5x287mm	· Higold IP design · Streamline design
HOLE SIZE	Φ 35mm	· Hot and cold temperature control
MATERIAL	Low lead brass	· Ceramic cartridge
COLOR	Rosy Gold	



B3 SERIES

B3 Series Hot And Cold Basin Faucet

ART.NO. **821312 / 821315**

INFORMATION



821312

821315

SIZE 51x168x146mm
53x208x271mm
HOLE SIZE Φ 32-35mm
MATERIAL Low lead brass
COLOR Chrome

- Higold IP design
- Honeycomb bubbler
- Stable and durable construction
- Hot and cold dual control

ART.NO. **821313 / 821316**

INFORMATION



821313

821316

SIZE 51x168x146mm
53x208x271mm
HOLE SIZE Φ 32-35mm
MATERIAL Low lead brass
COLOR Gun Grey

- Higold IP design
- Honeycomb bubbler
- Stable and durable construction
- Hot and cold dual control

ART.NO. **821314 / 821317**

INFORMATION



821314

821317

SIZE 51x168x146mm
53x208x271mm
HOLE SIZE Φ 32-35mm
MATERIAL Low lead brass
COLOR Rosy Gold

- Higold IP design
- Honeycomb bubbler
- Stable and durable construction
- Hot and cold dual control



FAUCET SERIES

Hot And Cold Basin Faucet

ART.NO. 607036 / 607037 INFORMATION



607036 607037

SIZE	149x135mm 270x148mm	· Artistic modeling · Soft bubble water
HOLE SIZE	Φ 35mm	
MATERIAL	Brass + Zinc alloy	
COLOR	Chrome	

ART.NO. 607056 / 607052 INFORMATION



607056 607052

SIZE	149x135mm 270x148mm	· Artistic modeling · Soft bubble water
HOLE SIZE	Φ 35mm	
MATERIAL	Brass + Zinc alloy	
COLOR	Matt Black	

ART.NO. 607055 / 607051 INFORMATION



607055 607051

SIZE	149x135mm 270x148mm	· Artistic modeling · Soft bubble water
HOLE SIZE	Φ 35mm	
MATERIAL	Brass + Zinc alloy	
COLOR	Bronze	



B1 SERIES SHOWERS

pininfarina design

SIMPLE AND ELEGANT, ENJOY LIGHT LUXURY

Welding high headquarters of IP design, stylist Pininfarina is Italy.
Show exquisite technology and senior luxurious feeling





B1 SERIES

B1 Series Multi-functional Shower



ART.NO. **820500**

INFORMATION

SIZE 355x400x(867-1217)mm
 MATERIAL Brass
 COLOR Chrome
 APERTURE 150mm

- Higold IP design
- Function switch with one click
- Underside waterfall outlet
- Handheld with three-function
- All-in-one shelf



ART.NO. **820501**

INFORMATION

SIZE 355x400x(867-1217)mm
 MATERIAL Brass
 COLOR Gun Grey
 APERTURE 150mm

- Higold IP design
- Function switch with one click
- Underside waterfall outlet
- Handheld with three-function
- All-in-one shelf



ART.NO. **820502**

INFORMATION

SIZE 355x400x(867-1217)mm
 MATERIAL Brass
 COLOR Rose Gold
 APERTURE 150mm

- Higold IP design
- Function switch with one click
- Underside waterfall outlet
- Handheld with three-function
- All-in-one shelf



B2 SERIES

pininfarina design

ENJOY THE WARM SHOWER IN THE STARRY RAINY CURTAIN

Concise design, collocation of all kinds of style of the bathroom.
At bath, make life more comfortable.



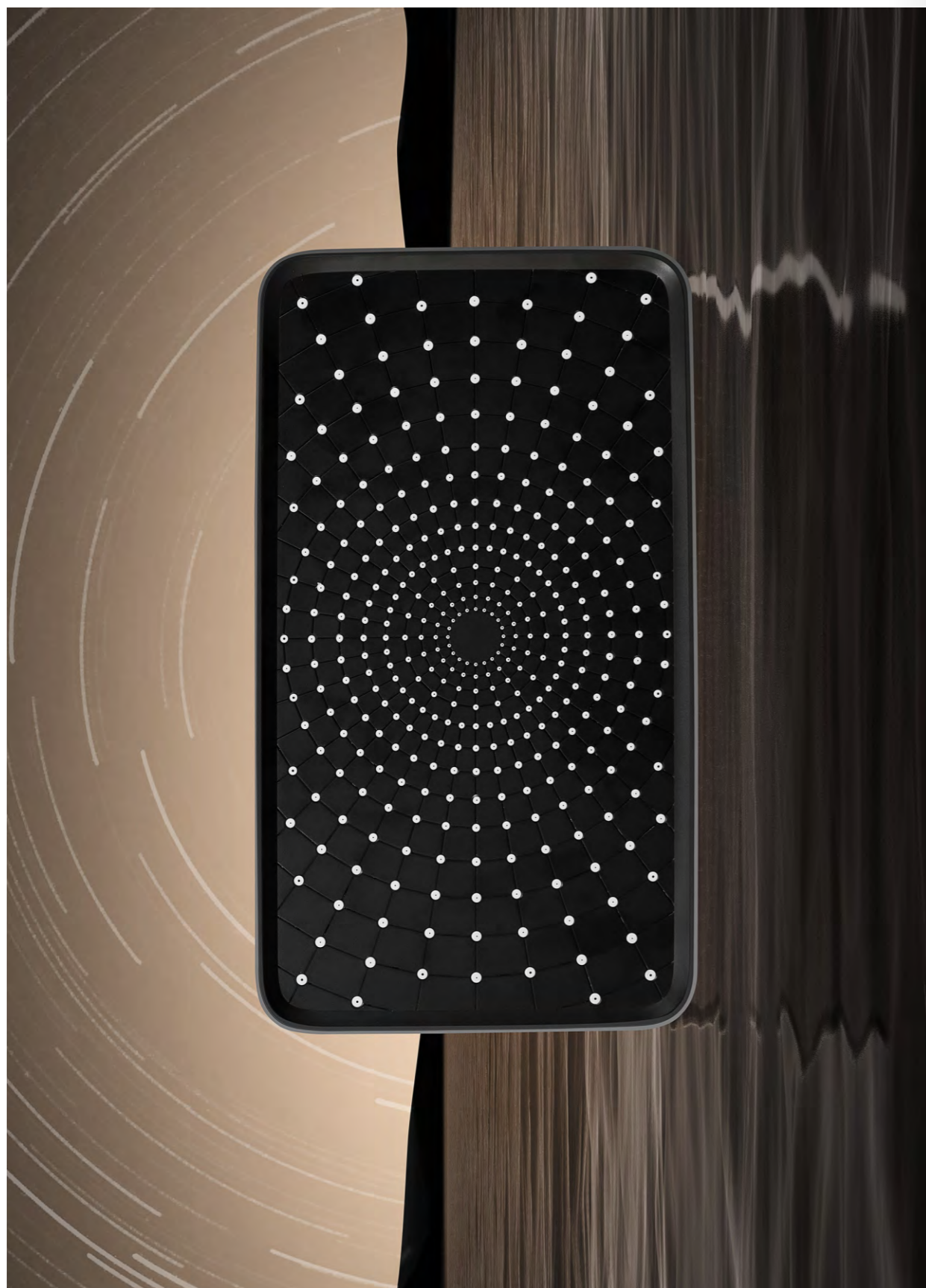

B2 SERIES

B2 Series Constant Temperature Multi-functional Shower



ART.NO. **820503**

INFORMATION

SIZE 340x412x(870-1220)mm
 MATERIAL Brass
 COLOR Streamer Chrome Silver
 APERTURE 145-155mm

· Thermostatic, double spin control
 · MAX widescreen top shower spray
 · Hidden waterfall water outlet
 · Handheld with three-function
 · Large glass floating shelf



ART.NO. **820504**

INFORMATION

SIZE 340x412x(870-1220)mm
 MATERIAL Brass
 COLOR Galaxy Brushed Grey
 APERTURE 145-155mm

· Thermostatic, double spin control
 · MAX widescreen top shower spray
 · Hidden waterfall water outlet
 · Handheld with three-function
 · Large glass floating shelf



ART.NO. **820505**

INFORMATION

SIZE 340x412x(870-1220)mm
 MATERIAL Brass
 COLOR Nebula Rose Gold
 APERTURE 145-155mm

· Thermostatic, double spin control
 · MAX widescreen top shower spray
 · Hidden waterfall water outlet
 · Handheld with three-function
 · Large glass floating shelf