

HIGOLD®

Guangdong Higold Home Co.,Ltd
Kitchen Hardware Division

Add: No.36, Shunye East Road, Xingtan Town, Shunde District,
Foshan City, Guangdong Province, China, 528325, P.R.C

T: +86 757 2738 6292

F: +86 757 2738 6279

E: sales_sink@higold.com.cn

W: www.higold.com.cn



HIGOLD®

KITCHEN SINK PRODUCT



HIGOLD KITCHEN SINK NEW CATALOGUE

KITCHEN **SINK**



Brief Introduction



Guangdong HIGOLD Kitchen Hardware Co., Ltd. is an diversified innovative technology enterprise with high-end functional hardware, intelligent Kitchenware and ecological chain of smart home furnishing, outdoor furniture and e-commerce etc. It is a high-end brand in China's functional hardware industry and has occupied the position of unicorn in the national sales and market share for five consecutive years. With a production area of 200,000 square meters, more than 2,000 employees and 180 of them are in R&D field, HIGOLD Star Factory is currently a large-scale functional hardware R&D and manufacturing base in Asia. HIGOLD as a national high-tech enterprise, owns the national level engineering technology research center and institute, at the same time establishes HIGOLD German design branch in Cologne, Germany, and a joint design institute established by the team of Turin. HIGOLD also build the JV institute with Pininfarina in Italy; with more than 300 independent innovation patents, it is the world-renowned German Red Dot Design Award winner. HIGOLD functional hardware products are selling to 86 countries and regions worldwide, and the marketing network covers the whole world. It has more than 180 general agents in domestic cities and up to 80,000 special cabinet and wardrobe stores, which is a strategic cooperative brand for domestic first-line real estate brands and home furnishing brands. HIGOLD is renowned in the industry by the excellent quality and innovative design.

Founder & President of the HIGOLD group
Mr. Alwin Ou



reddot design award

MR Jinfeng Ou
No. 21, Xinglong Rd, Xingtan Town, Shunde Area
528325 Foshan
China P.R

Essen / Germany, March 2017

Your success in the Red Dot Award: Product Design 2017

Dear Mr Ou

Congratulations! Your product has been awarded in the Red Dot Award: Product Design 2017. On behalf of all Red Dot jurors, allow me to congratulate you sincerely on your success.

This year, we received submissions from 54 countries. The Red Dot Award: Product Design thus stands more than ever for one of the most renowned evaluation processes for good design and innovation. All of the products entered were assessed individually by an independent and international jury of experts.

You have every reason to be proud of your award as you came out on top in a comparison with the best in the industry. Order your Winner Package now, and use the Red Dot Winner Label as well as all of the other benefits for your communication from 3 April. Furthermore, your product will be presented for one year in the Red Dot Design Museum, the largest museum for contemporary design.

I look forward to welcoming you in Essen on 3 July to celebrate your success with you at the Red Dot Gala and the subsequent Designer's Night.

Best regards

Professor Dr Peter Zec
Founder and president of Red Dot

icook
barbecue at home

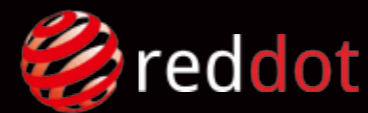

Honor & Design



The winner of 2014 Red Dot Award

Won the 2014 Red Dot Award-the "Oscar" of global design industry

The winner of 2017 Red Dot Award

The Water Dispens Won the 2017 Red Dot Award

The winner of 2018 Red Dot Award

Won the 2018 Red Dot Award-the "Oscar" of global design industry

The Winner of Gloden Hook Prize

Higold won 4 awards in the 3rd China Whole kitchen design competition

The Winner of Red Star Design Award

The winner of 2016 POPAI Award in Greater China

The Top 10 strategic supplier of Glodenhome

Longterm Strategic partner of Well known kitchen cabinet enterprises

Kitchen functional hardware national standard drafting unit

HIGOLD has been the chief drafter of kitchen functional hardware national standards since 2014



reddot design award
winner

Reddot Design Award in
2014,2017,2018



Red Star
Design Award



Golden Hook Prize



Pinfarina Co-
designing institute



National Standards Maker
of Kitchen Hardware
Industry



GS Quality Test
Certification



BSCI certification



ISO 9001 Quality
Management Certification



National High-
Tech Enterprise







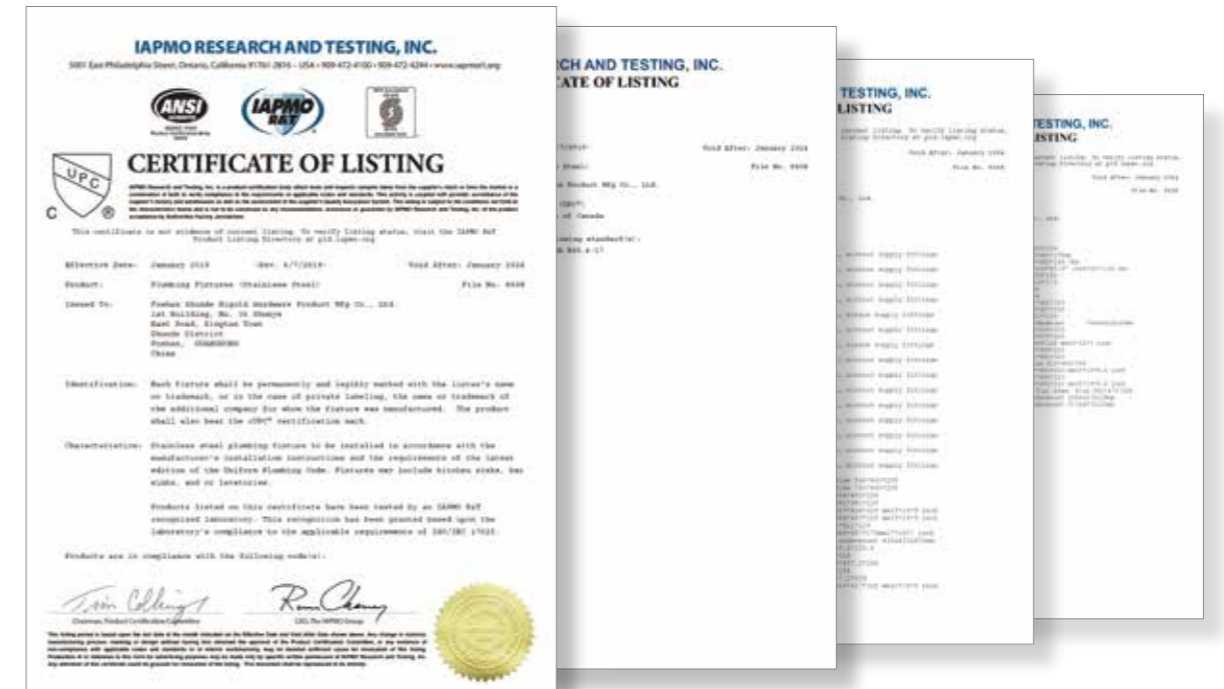





















Top ten Chinese
enterprises of kitchen and
bathroom accessories

Product Certificate







ASIA

	China	Beijing
	India	New Delhi
	Saudi Arabia	Riyadh
	Korea	Seoul
	UAE	Dubai
	Thailand	Bangkok
	Malaysia	Kuala Lumpur
	Singapore	Singapore
	Vietnam	Hanoi
	Philippines	Manila
	Indonesia	Jakarta
	Iran	Tehran
	Iraq	Baghdad
	Qatar	Doha
	Lebanon	Beirut
	Pakistan	Karachi
	Oman	Muscat
	Kuwait	Kuwait
	Syria	Damascus
	Jordan	Amman
	Bahrain	Manama
	Palestine	East Jerusalem
	Brunei	Bandar Seri Begawan
	Myanmar	Mandalay
	Cambodia	Phnom Penh
	Sri Lanka	Colombo

EUROPE

	Austria	Linz
	France	Paris
	Germany	Hamburg
	Italy	Rome
	Holland	Rotterdam
	Russia	Moscow
	Spain	Barcelona
	Switzerland	Bern
	UK	London
	Ukraine	Kiev
	Denmark	Copenhagen
	Sweden	Stockholm
	Norway	Oslo
	Finland	Helsinki
	Portugal	Lisbon
	Greece	Athens
	Belgium	Brussels
	Poland	Warsaw



AFRICA

	Egypt	Cairo
	South Africa	Cape Town
	Algeria	Algiers
	Nigeria	Lagos Nigeria
	Libya	Tripoli





OCEANIA

	Australia	Sydney
	Newzealand	Auckland

SOUTH AMERICA

	Brazil	Sao Paulo
	Columbia	Bogota
	Argentina	Buenos Aires
	Chile	Santiago
	Peru	Lima
	Bolivia	La Paz
	Ecuador	Quito

NORTH AND CENTRAL AMERICA

	Canada	Toronto
		Vancouver
		Montreal
	Mexico	Mexico City
	America	New York
		Los Angeles
		Chicago
		Houston
		Philadelphia
		San Francisco
		Atlanta
		Boston
	Panama	Panama

HIGOLD Sales Network



TECHNOLOGY AND PROCESS

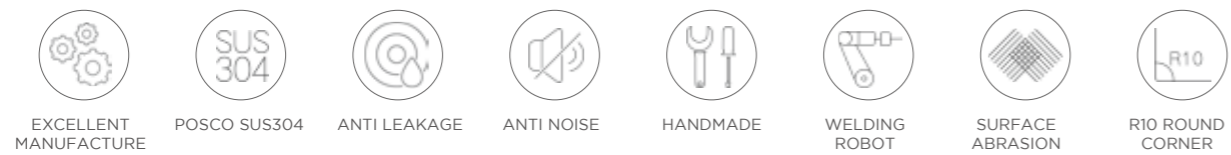

Brushed Surface



Radius 10 Corner



Numerical control welding technology



Anti noise



Laser cutting



Anti-condensation spray



Hand grinding



Basin wall vertical process

WASTE & OVERFLOW

The sink becomes waste if you can't find a good waste for it. With stainless steel shell, our waste set perfectly match the sinks in color and style. Rubber gasket inside design seals the gap to avoid any leakage.

Overflow, with or without, choice is yours. Redundant water drains from this hole in case you forget to turn off the faucet.





HIGOLD KITCHEN SINK NEW CATALOGUE

MENU

013	EUROPE SERIES
031	NORTH AMERICA SERIES
051	HIGOLD CREATIVE SERIES
061	HANDMADE-LIKE PRESSING SINKS
067	PRESSING SINKS
079	KITCHEN FAUCETS
089	ACCESSORIES



EUROPE SERIES



Intelligent
Kitchen Sink

What pops into your mind while heard the word "Europe"? London Buckingham, Quiet Belgian Town, Champs Elysees, Prague Square or Dutch Red-light District?

Europe, a magical land which cultivated the most ancient and civilized literature, philosophy and science, it is also the world hub for fashion and art. Pursuing ultimacy, the life notion for Europeans, based on which, we create Higold European series sinks.

In this series, every sink embodies the philosophy of European life. Normal single bowl sinks feed the taste of simplicity and purity. Sinks with tray illustrate the streamline design and craving for pragmatism. Butterfly corner sinks present the appreciation for art and aesthetics.

To be more European, you need a Higold European sink.





KITCHEN SINK 954002



Information

Product Dimension (LxWxD)	1000x510x220mm
Material	SS#304
Thickness	1.2mm
Corner	Radius 10
Cutout Size (Topmount)	976mmx486mmxR10

Description

Brushed surface;
Single bowl with tray;
With bending edge;
With sound pad and undercoating;
Optional accessories:
Drainer, Colander, Chopping board, Grid,
Rollmat, Soap dispenser, Wire basket.

KITCHEN SINK 955010

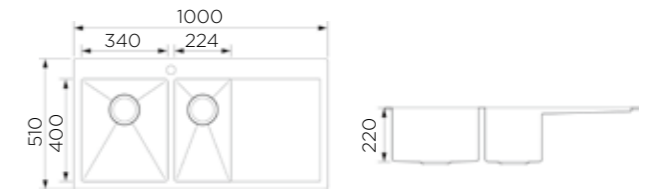

Information

Product Dimension (LxWxD)	1000x510x220mm
Material	SS#304
Thickness	1.2mm
Corner	Radius 10
Cutout size (Topmount)	976mmx486mmxR10

Description

Brushed surface;
Double bowl with tray;
With bending edge;
With sound pad and undercoating;
Optional accessories:
Drainer, Colander, Chopping board, Grid,
Rollmat, Soap dispenser, Wire basket.

KITCHEN SINK 904003



Information

Product Dimension (LxWxD)	1000x450x220mm
Material	SS#304
Thickness	1.2mm
Corner	Radius 10
Cutout size (Topmount)	976mmx486mmxR10
Cutout size (Undermount)	955mmx405mmxR12

Description

Brushed surface;
Single bowl with tray;
With sound pad and undercoating;
Optional accessories:
Drainer, Colander, Chopping board, Grid,
Rollmat, Soap dispenser, Wire basket.

KITCHEN SINK 955004

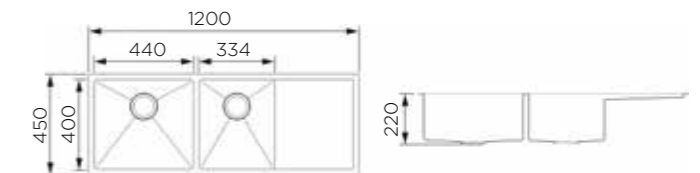

Information

Product Dimension (LxWxD)	1200x450x220mm
Material	SS#304
Thickness	1.2mm
Corner	Radius 10
Cutout size (Topmount)	1180mmx430mmxR10
Cutout size (Undermount)	1155mmx405mmxR12.5

Description

Brushed surface;
Double bowl with tray;
With sound pad and undercoating;
Optional accessories:
Drainer, Colander, Chopping board, Grid,
Rollmat, Soap dispenser, Wire basket.

KITCHEN SINK 953337

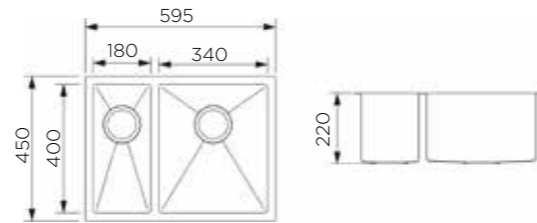

Information

Product Dimension (LxWxD)	595x450x220mm
Material	SS#304
Thickness	1.2mm
Corner	Radius 10
Cutout size (Topmount)	575x430mm
Cutout size (Undermount)	550x405mm

Description

Brushed surface;
Double bowl;
With sound pad and undercoating;
Optional accessories:
Drainer, Colander, Chopping board, Grid,
Rollmat, Soap dispenser, Wire basket.

KITCHEN SINK 953003

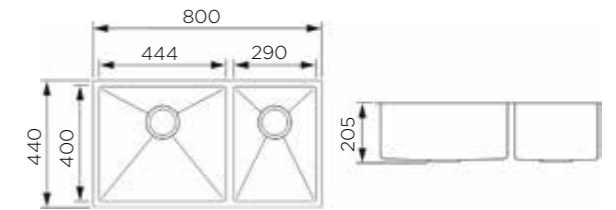

Information

Product Dimension (LxWxD)	800x440x205mm
Material	SS#304
Thickness	1.2mm
Corner	Radius 10
Cutout size (Topmount)	780mmx420mmxR10
Cutout size (Undermount)	755mmx395mmxR12

Description

Brushed surface;
Double bowl;
With sound pad and undercoating;
Optional accessories:
Drainer, Colander, Chopping board, Grid,
Rollmat, Soap dispenser, Wire basket.

KITCHEN SINK 953338

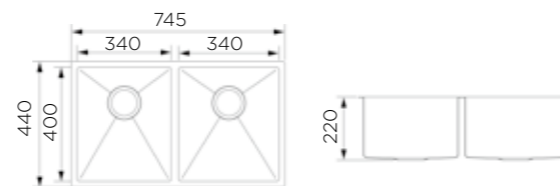

Information

Product Dimension (LxWxD)	745x440x220mm
Material	SS#304
Thickness	1.2mm
Corner	Radius 10
Cutout size (Topmount)	725mmx420mmxR10
Cutout size (Undermount)	710mmx405mmxR12

Description

Brushed surface;
Double bowl;
With sound pad and undercoating;
Optional accessories:
Drainer, Colander, Chopping board, Grid,
Rollmat, Soap dispenser, Wire basket.

KITCHEN SINK 953013

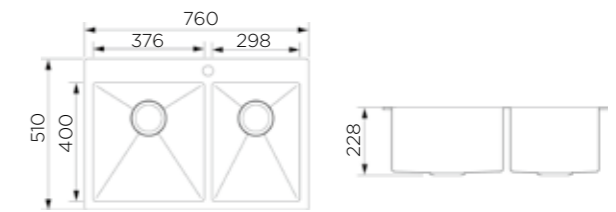

Information

Product Dimension (LxWxD)	760x510x228mm
Material	SS#304
Thickness	1.2mm
Corner	Radius 10
Cutout size (Topmount)	735mmx485mmxR10

Description

Brushed surface;
Double bowl;
With bending edge;
With sound pad and undercoating;
Optional accessories:
Drainer, Colander, Chopping board, Grid,
Rollmat, Soap dispenser, Wire basket.

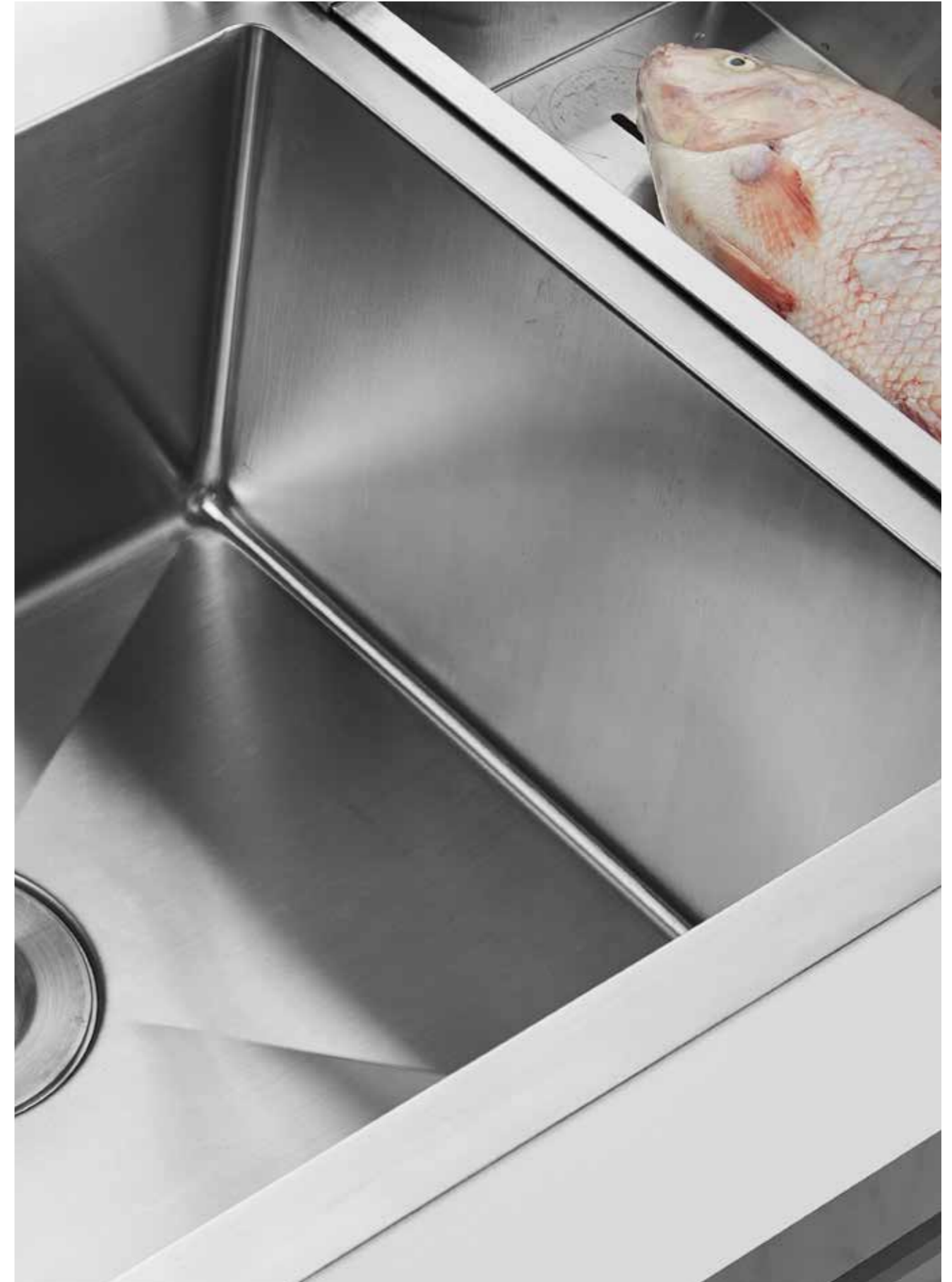



KITCHEN SINK 956001

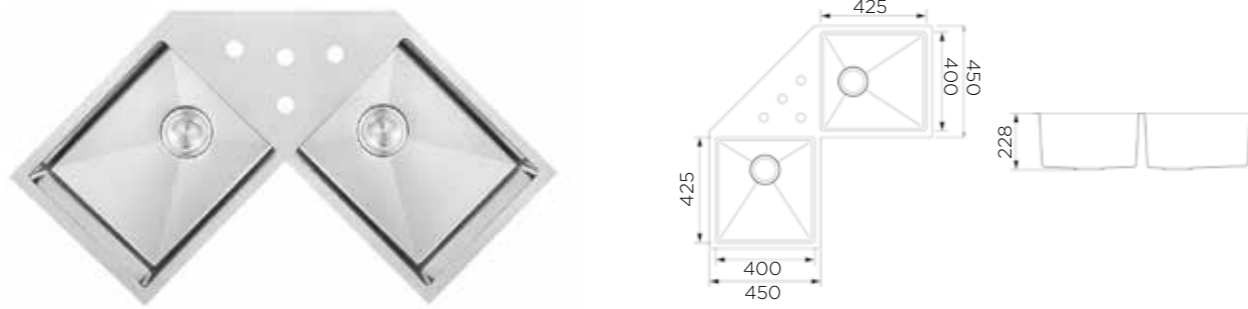

Information

Product Dimension (LxWxD)	900x900x228mm
Material	SS#304
Thickness	1.2mm
Corner	Radius 10

Description

Brushed surface;
 Corner double bowl;
 With sound pad and undercoating;
 Optional accessories:
 Drainer, Colander, Chopping board, Grid,
 Rollmat, Soap dispenser, Wire basket.

KITCHEN SINK 951106

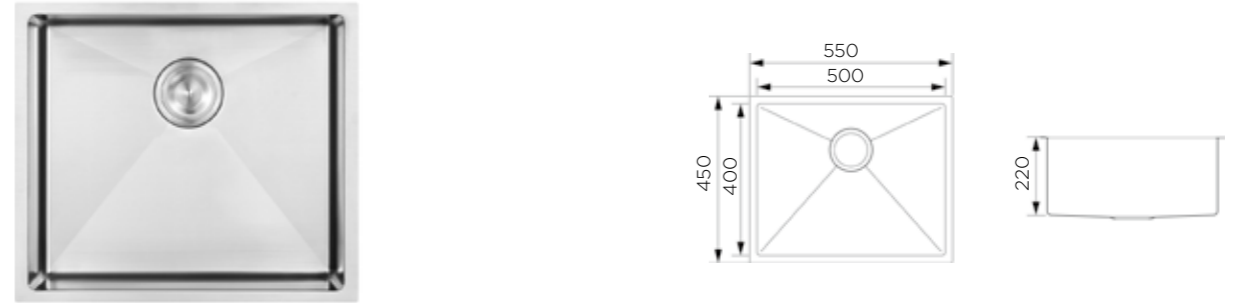

Information

Product Dimension (LxWxD)	550x450x220mm
Material	SS#304
Thickness	1.2mm
Corner	Radius 10
Cutout size (Topmount)	530x430mm
Cutout size (Undermount)	405x505mm

Description

Brushed surface;
 Single bowl;
 With sound pad and undercoating;
 Optional accessories:
 Drainer, Colander, Chopping board, Grid,
 Rollmat, Soap dispenser, Wire basket.

KITCHEN SINK 951243

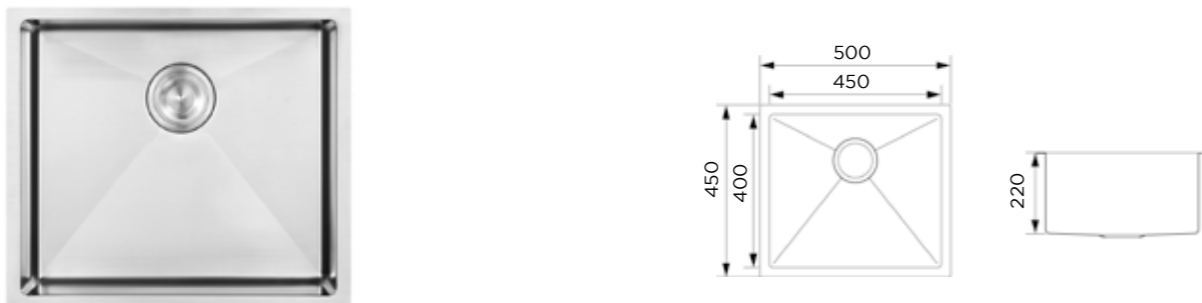

Information

Product Dimension (LxWxD)	500x450x220mm
Material	SS#304
Thickness	1.2mm
Corner	Radius 10
Cutout size (Topmount)	480mmx430mmxR10
Cutout size (Undermount)	455mmx405mmxR12

Description

Brushed surface;
 Single bowl;
 With sound pad and undercoating;
 Optional accessories:
 Drainer, Colander, Chopping board, Grid,
 Rollmat, Soap dispenser, Wire basket.

KITCHEN SINK 951251

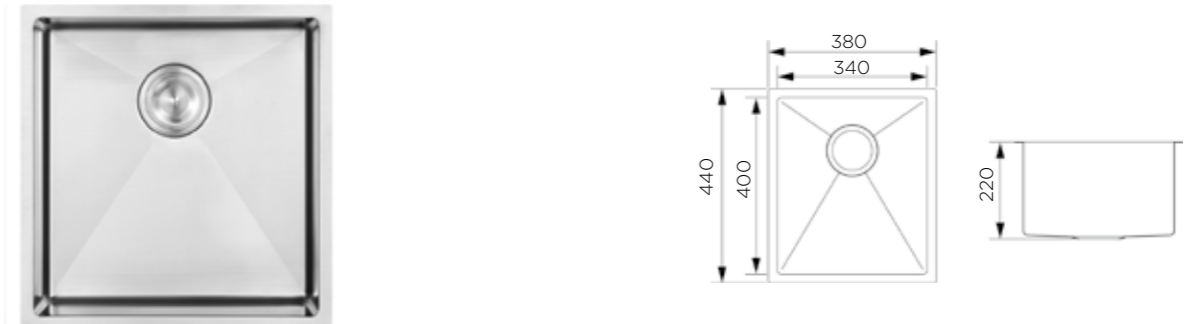

Information

Product Dimension (LxWxD)	380x440x220mm
Material	SS#304
Thickness	1.2mm
Corner	Radius 10
Cutout size (Topmount)	360mmx420mmxR10
Cutout size (Undermount)	345mmx405mmxR12

Description

Brushed surface;
 Single bowl;
 With sound pad and undercoating;
 Optional accessories:
 Drainer, Colander, Chopping board, Grid,
 Rollmat, Soap dispenser, Wire basket.

KITCHEN SINK 951009

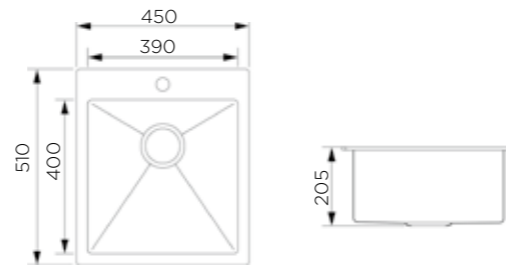

Information

Product Dimension (LxWxD)	450x510x205mm
Material	SS#304
Thickness	1.2mm
Corner	Radius 10
Cutout size (Topmount)	475mmx485mmxR10

Description

Brushed surface;
Single bowl;
With bending edge;
With sound pad and undercoating;
Optional accessories:
Drainer, Colander, Chopping board, Grid,
Rollmat, Soap dispenser, Wire basket.

KITCHEN SINK 952010

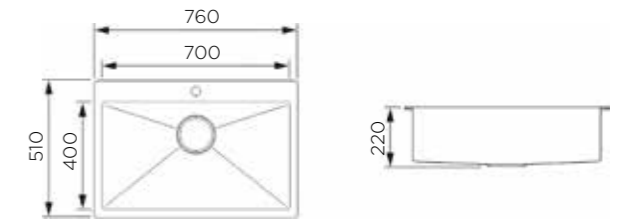

Information

Product Dimension (LxWxD)	760x510x220mm
Material	SS#304
Thickness	1.2mm
Corner	Radius 10
Cutout size (Topmount)	736mmx486mmxR10

Description

Brushed surface;
Single bowl;
With bending edge;
With sound pad and undercoating;
Optional accessories:
Drainer, Colander, Chopping board, Grid,
Rollmat, Soap dispenser, Wire basket.

KITCHEN SINK 951013

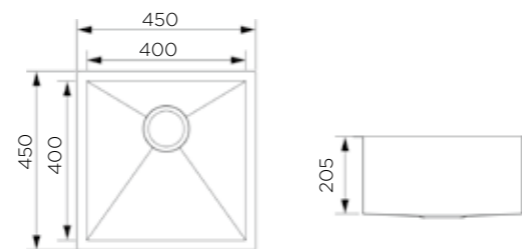

Information

Product Dimension (LxWxD)	450x450x205mm
Material	SS#304
Thickness	1.2mm
Corner	Radius 0
Cutout size (Topmount)	430mmx430mm
Cutout size (Undermount)	405x405mm

Description

Brushed surface;
Single bowl;
With sound pad and undercoating;
Optional accessories:
Drainer, Colander, Chopping board, Grid,
Rollmat, Soap dispenser, Wire basket.

KITCHEN SINK 952160

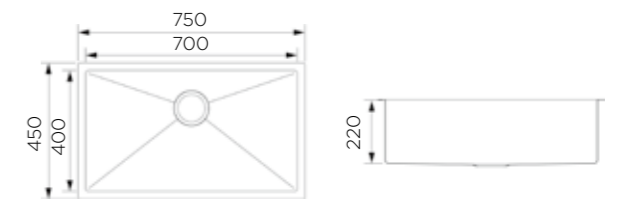

Information

Product Dimension (LxWxD)	750x450x220mm
Material	SS#304
Thickness	1.2mm
Corner	Radius 10
Cutout size (Topmount)	730mmx430mmxR10
Cutout size (Undermount)	705mmx405mmxR12

Description

Brushed surface;
Single bowl;
With sound pad and undercoating;
Optional accessories:
Drainer, Colander, Chopping board, Grid,
Rollmat, Soap dispenser, Wire basket.



NORTH AMERICA SERIES



Intelligent
Kitchen Sink

Being open and traditional, that's what defines North America, a continent of colony, nurturing two countries, Canada and The United States, which empower the whole world economically, militarily and politically.

Higold North America Series, successfully inherited the core value of American freedom and democracy by providing multiple sink choices for every kitchen: single, double, topmount, undermount, apron etc. Size can be customized and thickness ranges from 20G to 16G.

We know who you are and what you want, that's why we can be your best kitchen sink provider.

Higold North America Series sinks, focusing on practicability and large capacity, help to realize your American dream of a fancy kitchen.

Get one now to be your own kitchen master.

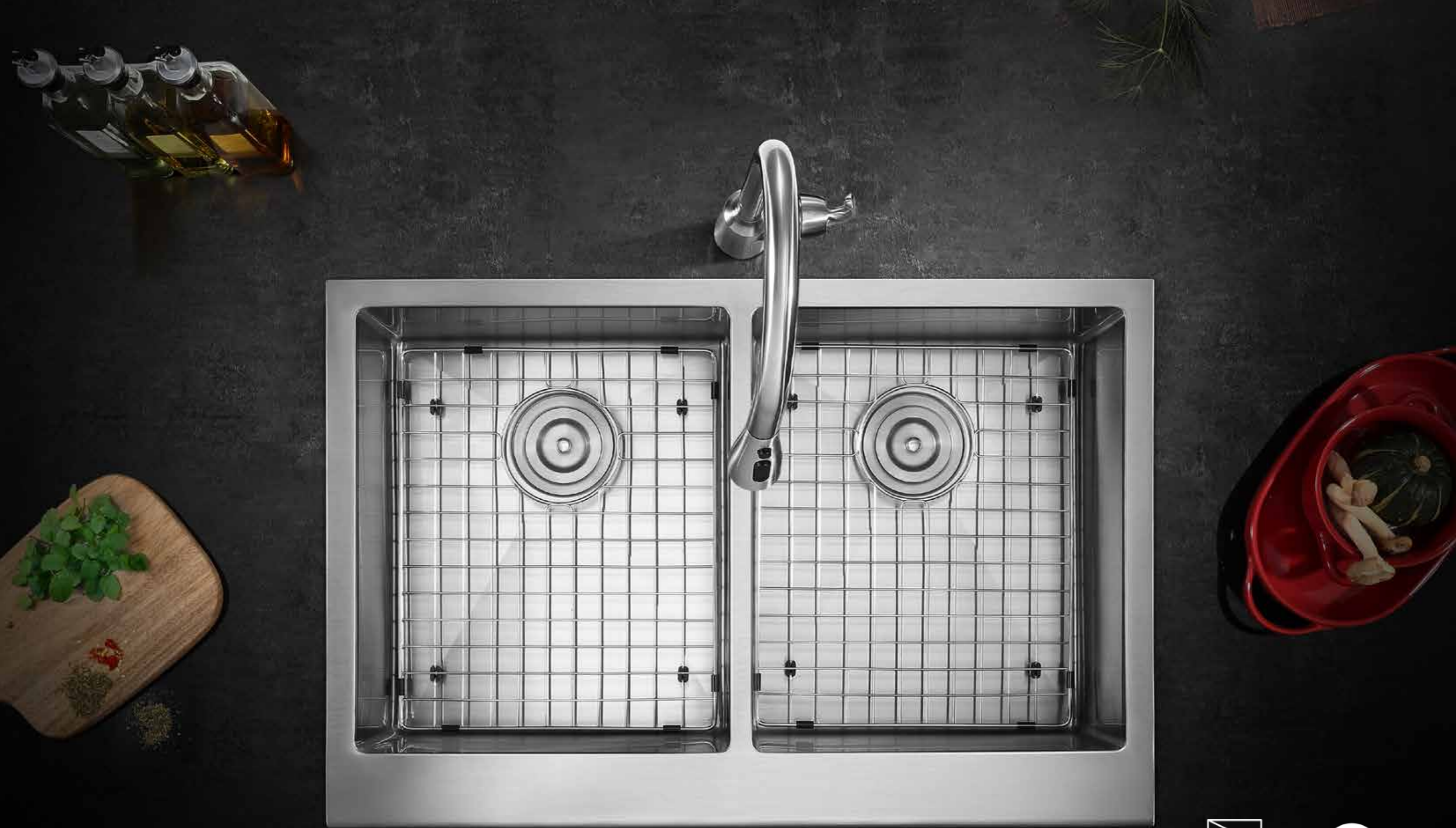





KITCHEN SINK 951252

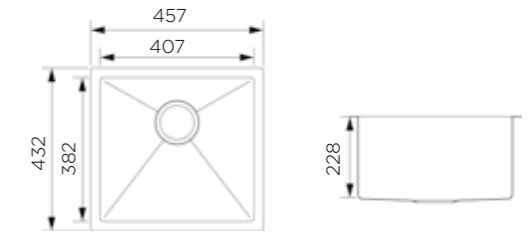

Information

Product Dimension (LxWxD)	18"x17"x9" 457x432x228mm
Material	SS#304
Thickness	1.2mm
Corner	Radius 10
Cutout size (Topmount)	437mmx412mmxR10
Cutout size (Undermount)	412mmx387mm

Description

Brushed surface;
Single bowl;
With sound pad and undercoating;
Optional accessories:
Drainer, Colander, Chopping board, Grid,
Rollmat, Soap dispenser, Wire basket.

KITCHEN SINK 901008

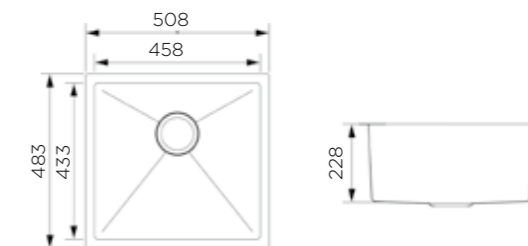

Information

Product Dimension (LxWxD)	20"x19"x9" 508x483x228mm
Material	SS#304
Thickness	1.2mm
Corner	Radius 10
Cutout size (Topmount)	488mmx463mmxR10
Cutout size (Undermount)	463mmx438mmxR12

Description

Brushed surface;
Single bowl;
With sound pad and undercoating;
Optional accessories:
Drainer, Colander, Chopping board, Grid,
Rollmat, Soap dispenser, Wire basket.



KITCHEN SINK 951147

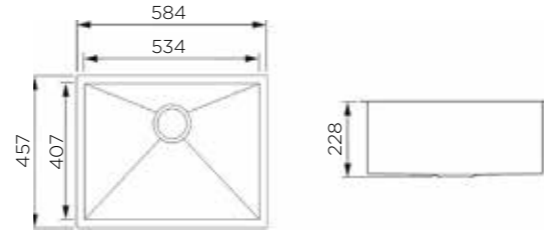

Information

Product Dimension (LxWxD)	23"x18"x9" 584x457x228mm
Material	SS#304
Thickness	1.2mm
Corner	Radius 0
Cutout size (Topmount)	564mmx437mm
Cutout size (Undermount)	539mmx412mm

Description

Brushed surface;
Single bowl;
With sound pad and undercoating;
Optional accessories:
Drainer, Colander, Chopping board, Grid,
Rollmat, Soap dispenser, Wire basket.

KITCHEN SINK 952167

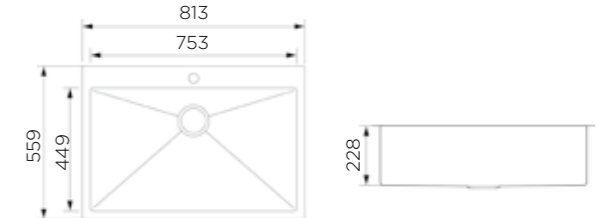

Information

Product Dimension (LxWxD)	32"x22"x9" 813x559x228mm
Material	SS#304
Thickness	1.2mm
Corner	Radius 10
Cutout size (Topmount)	789mmx535mmxR10

Description

Brushed surface;
Single bowl;
With sound pad and undercoating;
Optional accessories:
Drainer, Colander, Chopping board, Grid,
Rollmat, Soap dispenser, Wire basket.

KITCHEN SINK 952005

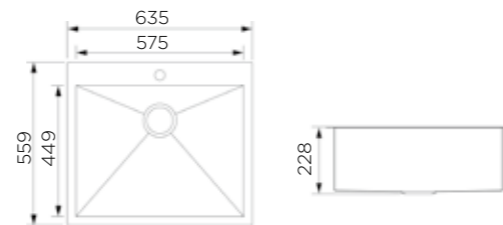

Information

Product Dimension (LxWxD)	25"x22"x9" 635x559x228mm
Material	SS#304
Thickness	1.2mm
Corner	Radius 0
Cutout size (Topmount)	611mmx535mm

Description

Brushed surface;
Single bowl;
With sound pad and undercoating;
Optional accessories:
Drainer, Colander, Chopping board, Grid,
Rollmat, Soap dispenser, Wire basket.

KITCHEN SINK 952161

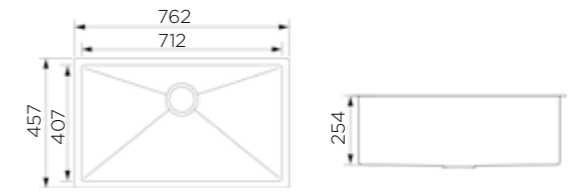

Information

Product Dimension (LxWxD)	30"x18"x10" 762x457x254mm
Material	SS#304
Thickness	1.2mm
Corner	Radius 10
Cutout size (Topmount)	742mmx437mmxR10
Cutout size (Undermount)	717mmx412mmxR12

Description

Brushed surface;
Single bowl;
With sound pad and undercoating;
Optional accessories:
Drainer, Colander, Chopping board, Grid,
Rollmat, Soap dispenser, Wire basket.

KITCHEN SINK 952165

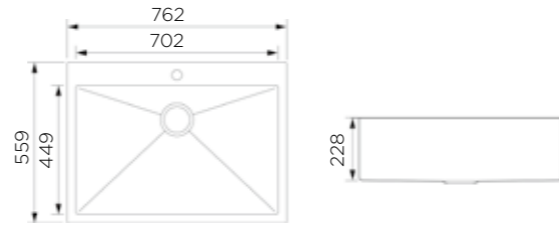

Information

Product Dimension (LxWxD)	30"x22"x9" 762x559x228mm
Material	SS#304
Thickness	1.2mm
Corner	Radius 10
Cutout size (Topmount)	738mmx535mmxR10

Description

Brushed surface;
Single bowl;
With sound pad and undercoating;
Optional accessories:
Drainer, Colander, Chopping board, Grid,
Rollmat, Soap dispenser, Wire basket.

KITCHEN SINK 952166

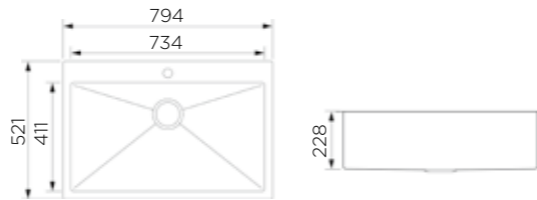

Information

Product Dimension (LxWxD)	31-1/4" x 20-1/2" x 9" 794x521x228mm
Material	SS#304
Thickness	1.2mm
Corner	Radius 10
Cutout size (Topmount)	770mmx497mmxR10

Description

Brushed surface;
Single bowl;
With sound pad and undercoating;
Optional accessories:
Drainer, Colander, Chopping board, Grid,
Rollmat, Soap dispenser, Wire basket.

KITCHEN SINK 952164

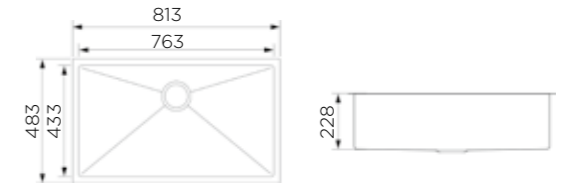

Information

Product Dimension (LxWxD)	32"x19"x9" 813x483x228mm
Material	SS#304
Thickness	1.2mm
Corner	Radius 10
Cutout size (Topmount)	793mmx463mmxR10
Cutout size (Undermount)	768mmx438mmxR12

Description

Brushed surface;
Single bowl;
With sound pad and undercoating;
Optional accessories:
Drainer, Colander, Chopping board, Grid,
Rollmat, Soap dispenser, Wire basket.

KITCHEN SINK 963036

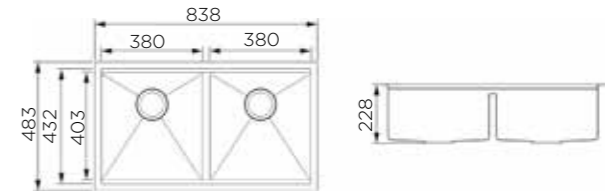

Information

Product Dimension (LxWxD)	33"x19"x9" 838x483x228mm
Material	SS#304
Thickness	1.2mm
Corner	Radius 10
Cutout size (Topmount)	818mmx463mmxR10
Cutout size (Undermount)	793mmx438mm

Description

Brushed surface;
Double bowl with step;
With sound pad and undercoating;
Optional accessories:
Drainer, Colander, Chopping board, Grid,
Rollmat, Soap dispenser, Wire basket.

KITCHEN SINK 953125

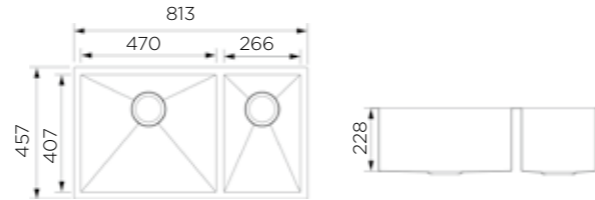

Information

Product Dimension (LxWxD)	32"x18"x9" 813x457x228mm
Material	SS#304
Thickness	1.2mm
Corner	Radius 0
Cutout size (Topmount)	793mmx437mmxR10
Cutout size (Undermount)	725mmx440mmxR12

Description

Brushed surface;
Double bowl;
With sound pad and undercoating;
Optional accessories:
Drainer, Colander, Chopping board, Grid,
Rollmat, Soap dispenser, Wire basket.

KITCHEN SINK 953349

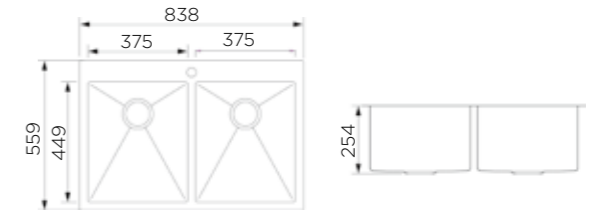

Information

Product Dimension (LxWxD)	33"x22"x10" 838x559x254mm
Material	SS#304
Thickness	1.2mm
Corner	Radius 10
Cutout size (Topmount)	814mmx535mmxR10

Description

Brushed surface;
Double bowl;
With sound pad and undercoating;
Optional accessories:
Drainer, Colander, Chopping board, Grid,
Rollmat, Soap dispenser, Wire basket.

KITCHEN SINK 953014

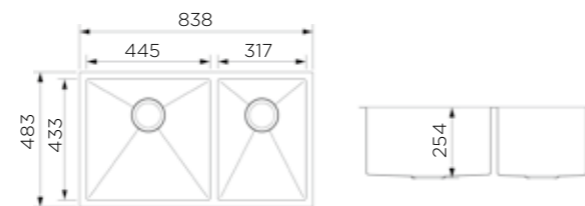

Information

Product Dimension (LxWxD)	33"x19"x10" 838x483x254mm
Material	SS#304
Thickness	1.2mm
Corner	Radius 10
Cutout size (Topmount)	818mmx463mmxR10
Cutout size (Undermount)	793mmx438mmxR12

Description

Brushed surface;
Double bowl;
With sound pad and undercoating;
Optional accessories:
Drainer, Colander, Chopping board, Grid,
Rollmat, Soap dispenser, Wire basket.

KITCHEN SINK 953350

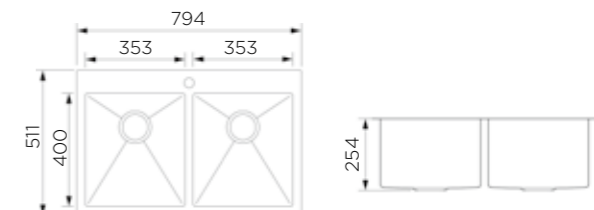

Information

Product Dimension (LxWxD)	31-1/4"x20-1/8"x10" 794x511x254mm
Material	SS#304
Thickness	1.2mm
Corner	Radius 10
Cutout size (Topmount)	770mmx487mmxR10

Description

Brushed surface;
Double bowl;
With sound pad and undercoating;
Optional accessories:
Drainer, Colander, Chopping board, Grid,
Rollmat, Soap dispenser, Wire basket.

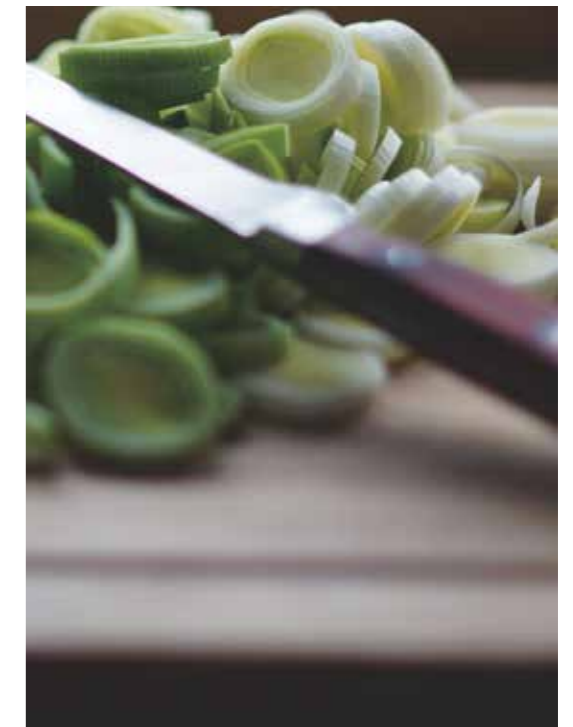

Handmade Kitchen Sink

DESIGN

Embedded installation design allows the sink and the countertop to blend into one, giving more perfect visual enjoyment and experience.

TECHNIQUE

Rounded corner and straight edge process realizes more rigid and durable product.

QUALITY

304 stainless steel plate and 1.2mm thickness steel resistant to rust for 50 years, fine brushing, high scratch resistance, surface repairable, eternally renewed.

FUNCTION

In addition to the traditional simple washing function of sink, there are more powerful functions: integration of storage and draining makes the sink the center of the whole kitchen.

FEATURES

HIGOLD abandoned complicated and cumbersome sewage system. Instead, simpler sewage system with higher reliability and large-diameter drainage pipe are adopted for efficient drainage.

KITCHEN SINK 957025

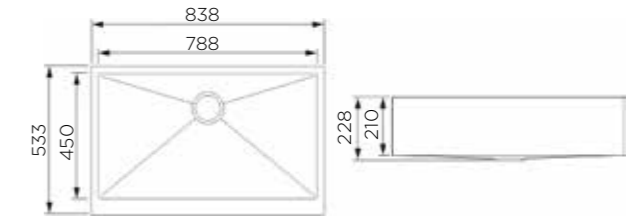

Information

Product Dimension (LxWxD)	33"x21"x9" 838x533x228mm
Material	SS#304
Thickness	1.2mm
Corner	Radius 10
Cutout size (Topmount)	840mmx500mm

Description

Brushed surface;
Single bowl with apron;
With sound pad and undercoating;
Optional accessories:
Drainer, Colander, Chopping board, Grid,
Rollmat, Soap dispenser, Wire basket.

KITCHEN SINK 957023

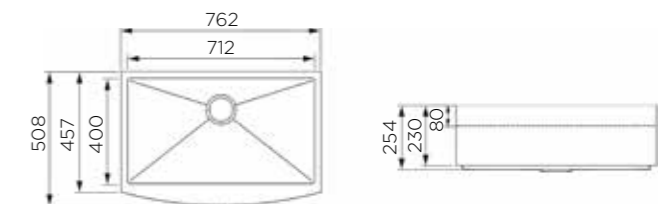

Information

Product Dimension (LxWxD)	30"x20"x10" 762x508x254mm
Material	SS#304
Thickness	1.2mm
Corner	Radius 10
Cutout size (Topmount)	765mmx457mmxR10

Description

Brushed surface;
Single bowl with apron;
With sound pad and undercoating;
Optional accessories:
Drainer, Colander, Chopping board, Grid,
Rollmat, Soap dispenser, Wire basket.

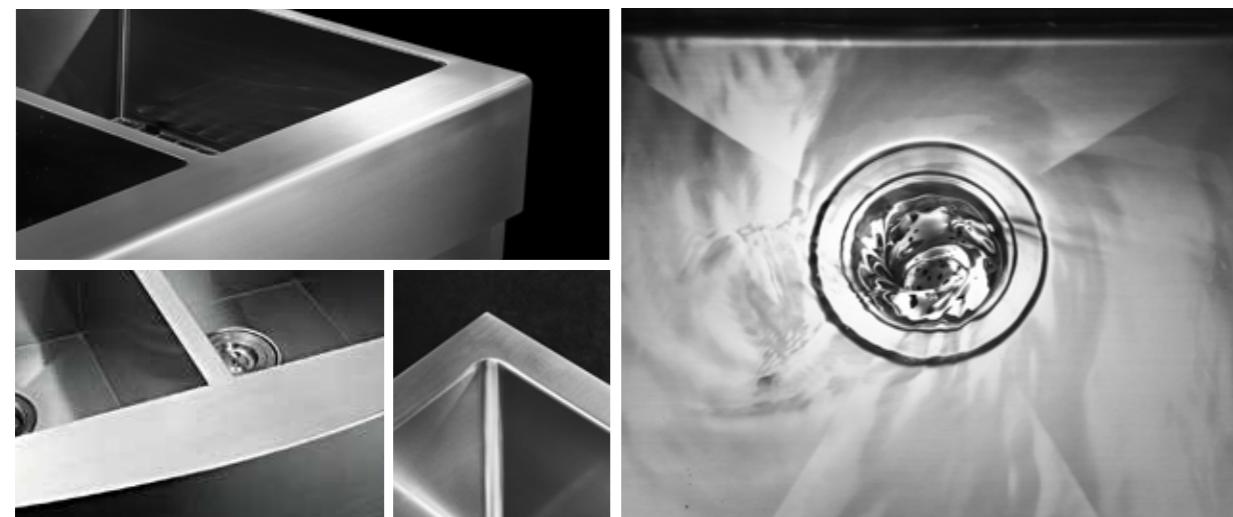

KITCHEN SINK 957026

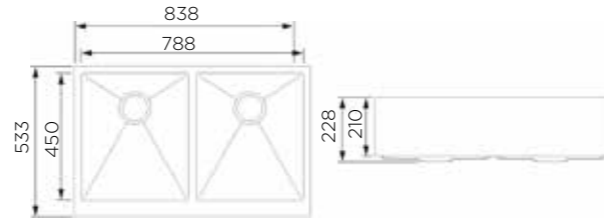

Information

Product Dimension (LxWxD)	33"x21"x9" 838x533x228mm
Material	SS#304
Thickness	1.2mm
Corner	Radius 10
Cutout size (Topmount)	840mmx500mm

Description

Brushed surface;
Double bowl with apron;
With sound pad and undercoating;
Optional accessories:
Drainer, Colander, Chopping board, Grid,
Rollmat, Soap dispenser, Wire basket.

KITCHEN SINK 957015

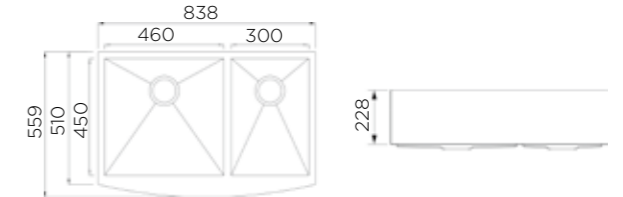

Information

Product Dimension (LxWxD)	33"x22"x9" 838x559x228mm
Material	SS#304
Thickness	1.2mm
Corner	Radius 0
Cutout size (Topmount)	838mmx500mm

Description

Brushed surface;
Double bowl with apron;
With sound pad and undercoating;
Optional accessories:
Drainer, Colander, Chopping board, Grid,
Rollmat, Soap dispenser, Wire basket.

KITCHEN SINK 957014

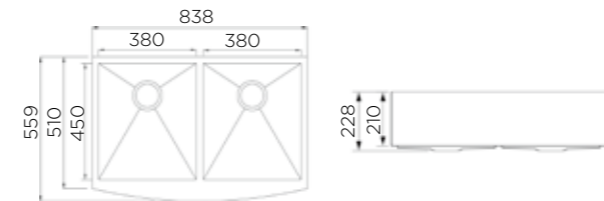

Information

Product Dimension (LxWxD)	33"x22"x9" 838x559x228mm
Material	SS#304
Thickness	1.2mm
Corner	Radius 0
Cutout size (Topmount)	838mmx510mm

Description

Brushed surface;
Double bowl with apron;
With sound pad and undercoating;
Optional accessories:
Drainer, Colander, Chopping board, Grid,
Rollmat, Soap dispenser, Wire basket.



HIGOLD CREATIVE SERIES



Intelligent
Kitchen Sink

Creation, a combination of wisdom and imagination, is the wheel of human development. Since the founding of Higold, we have been upholding "think big, do something new" as our core value, thanks to which, we have successfully won Reddot Award for several times and solidified our dominant position in kitchen hardware industry.

This series is a collection of smart ideas and new techniques. For example: sink with rear drainer, by moving the drainer set backwards, release more space under cabinet for storage. PVD sinks with nano treatment, feed your picky appetite on colors to perfect match your kitchen, while make the sink more durable and anti-scratch at the same time.

You've never been so proud and confident until you choose a Higold creative sink.



Rear Drainer Kitchen Sink

DESIGN

Initiative rear drainage design, table control and hidden decorative cover, perfect retractable drainage system, maximum utilization of space.

TECHNIQUE

The bottom of the sink is tilt, composite aluminum plastic brushed cover, multiple sunken step design is elegant and practical.

QUALITY

Imported 304 stainless steel and 1.2mm thickness steel resistant to rust for 50 years, fine brushing, high scratch resistance, surface repairable, eternally renewed.

FUNCTION

In addition to the traditional simple washing function of sink, there are more powerful functions. The original hidden rear basin design is not only elegant and practical, but also maximizes the storage space .

FEATURES

HIGOLD uses a table control drainage system with higher reliability and quick-fit large-diameter drainage pipe, making the sink easier to drain water and remove slags.

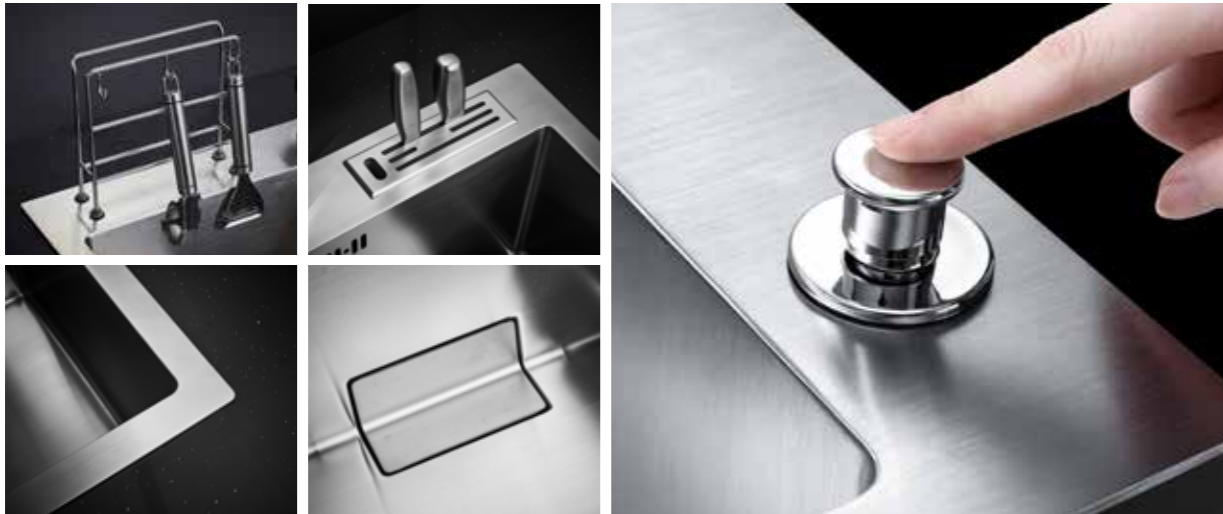

KITCHEN SINK 953206

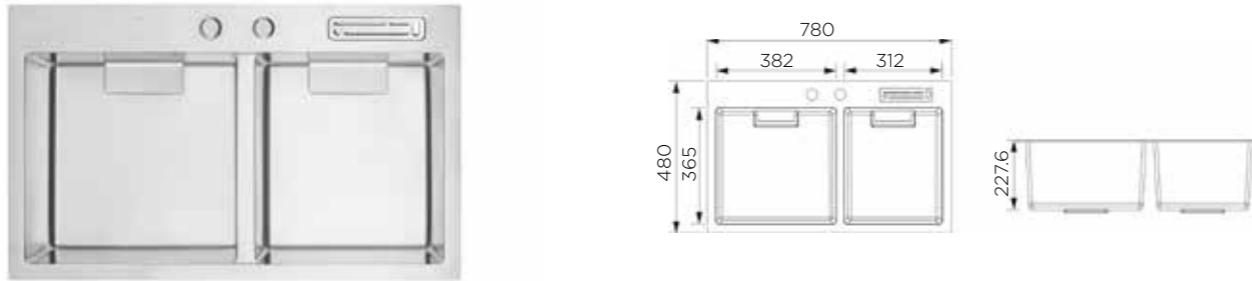

Information

Product Dimension (LxWxD)	780x480x227.6mm
Material	SS#304
Thickness	4mm(rim)+1.1mm(bowl)
Corner	Radius 10
Cutout size (Topmount)	756mmx456mmxR10

Description

Brushed surface;
 Double bowl with rear drainer;
 With sound pad and undercoating;
 Optional accessories:
 Drainer, Colander, Chopping board, Grid,
 Rollmat, Soap dispenser, Wire basket.

KITCHEN SINK 953092

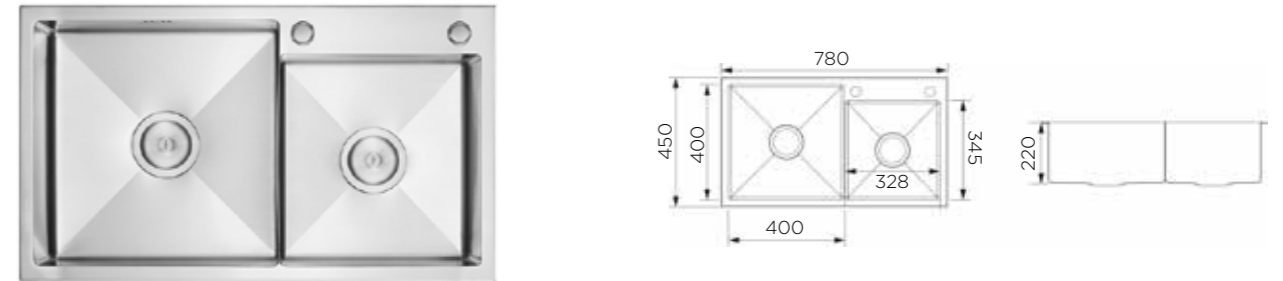

Information

Product Dimension (LxWxD)	780x450x220mm
Material	SS#304
Thickness	1.2mm
Corner	Radius 10
Cutout size (Topmount)	756mmx426mmxR10

Description

Brushed surface;
 Double bowl with narrow partition;
 With sound pad and undercoating;
 Optional accessories:
 Drainer, Colander, Chopping board, Grid,
 Rollmat, Soap dispenser, Wire basket.

KITCHEN SINK 952120

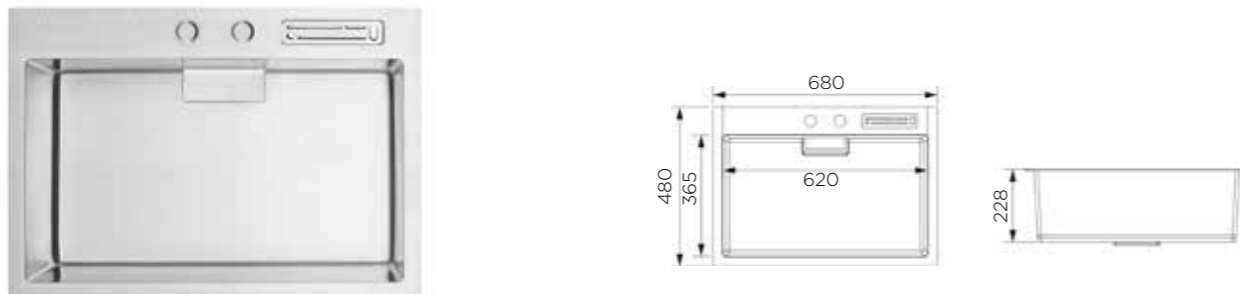

Information

Product Dimension (LxWxD)	680x480x228mm
Material	SS#304
Thickness	4mm(rim)+1.1mm(bowl)
Corner	Radius 10
Cutout size (Topmount)	656mmx456mmxR10

Description

Brushed surface;
 Single bowl with rear drainer;
 With sound pad and undercoating;
 Optional accessories:
 Drainer, Colander, Chopping board, Grid,
 Rollmat, Soap dispenser, Wire basket.

KITCHEN SINK 957022

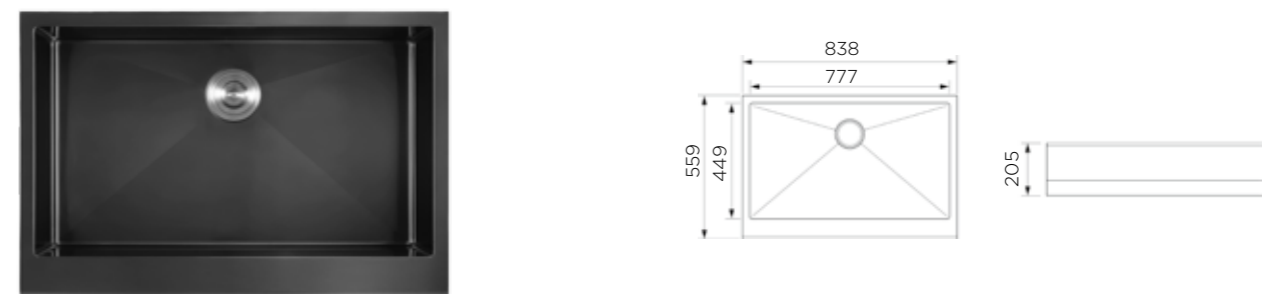

Information

Product Dimension (LxWxD)	838x559x205mm
Material	SS#304
Thickness	1.2mm
Corner	Radius 10

Description

Gunmetal PVD and Nano coated finishing;
 Single bowl with apron;
 With sound pad and undercoating;
 Optional accessories:
 Drainer, Colander, Chopping board, Grid,
 Rollmat, Soap dispenser, Wire basket.

KITCHEN SINK 904003

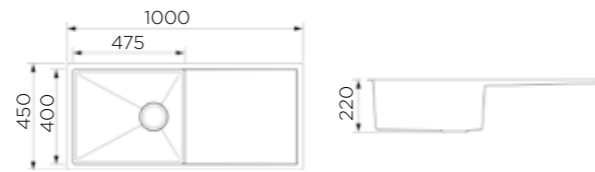

Information

Product Dimension (LxWxD)	1000x450x220mm
Material	SS#304
Thickness	1.2mm
Corner	Radius 10
Cutout size (Topmount)	980mmx430mmxR10
Cutout size (Undermount)	955mmx405mmxR12

Description

Golden PVD and Nano coated finishing;
Single bowl with tray;
With sound pad and undercoating;
Optional accessories:
Drainer, Colander, Chopping board, Grid,
Rollmat, Soap dispenser, Wire basket.

KITCHEN SINK 951243

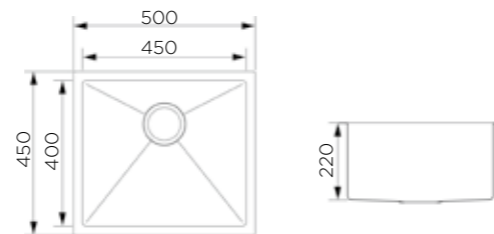

Information

Product Dimension (LxWxD)	500x450x220mm
Material	SS#304
Thickness	1.2mm
Corner	Radius 10
Cutout size (Topmount)	480mmx430mmxR10
Cutout size (Undermount)	455mmx405mmxR12.5

Description

Rose golden PVD and Nano coated finishing;
Single bowl;
With sound pad and undercoating;
Optional accessories:
Drainer, Colander, Chopping board, Grid,
Rollmat, Soap dispenser, Wire basket.

BATHROOM SINK 920151

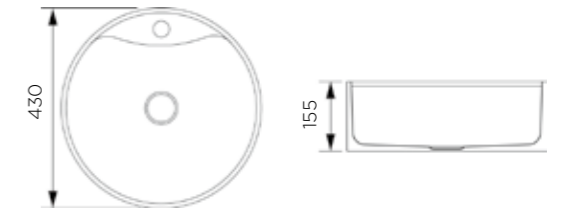

Information

Product Dimension (LxWxD)	430x430x155mm
Material	SS#304
Thickness	0.9mm
Bowl depth	155mm

Description

Bathroom sink;
Gunmetal black PVD and Nano coated finishing;
Round shape;
Optional accessories: Drainer;

BATHROOM SINK 920152

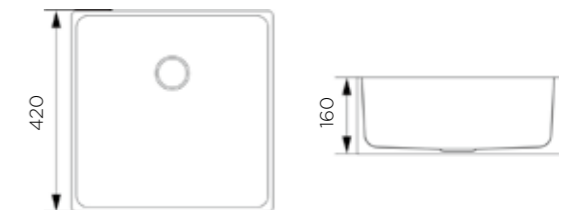

Information

Product Dimension (LxWxD)	420x420x160mm
Material	SS#304
Thickness	0.9mm
Bowl depth	155mm

Description

Bathroom sink;
Rose golden PVD and Nano coated finishing;
Square shape;
Optional accessories: Drainer;



HANDMADE-LIKE PRESSING SINKS

Intelligent
Kitchen Sink

Old saying goes, you can't have your cake and eat it too.

When you admire the grand shape, premium steel and fancy craftsmanship of a handmade sink, you must have been well prepared to pay the high price.

What if you don't? Or you have a limited budget?
If yes, then the following series Higold handmade-like pressing sinks are just made for you, adopting radius 15 pressing technology, we manufacture this kind of sink with handmade look, but at low cost.

Higold handmade-like pressing sink, affordable luxury, enjoy superiority without empty your pocket.

KITCHEN SINK 951254

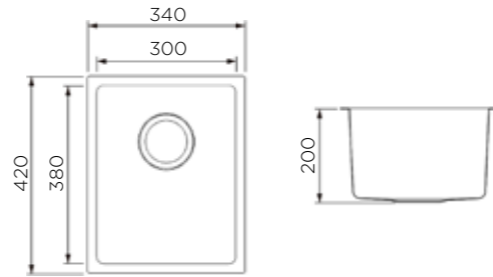

Information

Product Dimension (LxWxD)	340x420x200mm
Material	SS#304
Thickness	1.0mm
Corner	Radius 15
Cutout size (Topmount)	320mmx400mmxR10
Cutout size (Undermount)	305mmx385mmxR15

Description

Brushed surface;
Single bowl;
With sound pad and undercoating;
Optional accessories:
Drainer, Colander, Chopping board, Grid,
Rollmat, Soap dispenser, Wire basket.

KITCHEN SINK 952170

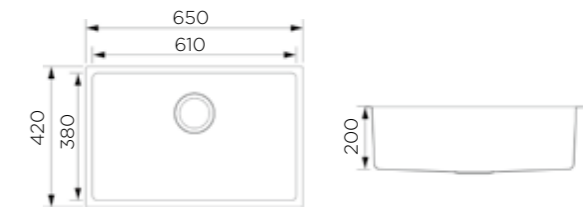

Information

Product Dimension (LxWxD)	650x420x200mm
Material	SS#304
Thickness	1.0mm
Corner	Radius 15
Cutout size (Topmount)	630mmx400mmxR10
Cutout size (Undermount)	615mmx385mmxR15

Description

Brushed surface;
Single bowl;
With sound pad and undercoating;
Optional accessories:
Drainer, Colander, Chopping board, Grid,
Rollmat, Soap dispenser, Wire basket.

KITCHEN SINK 951255

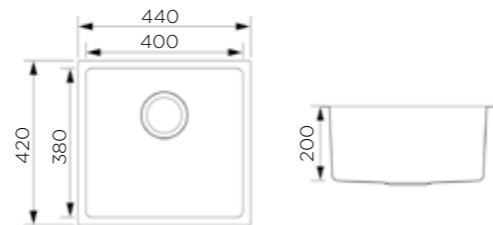

Information

Product Dimension (LxWxD)	440x420x200mm
Material	SS#304
Thickness	1.0mm
Corner	Radius 15
Cutout size (Topmount)	420mmx400mmxR10
Cutout size (Undermount)	405mmx385mmxR15

Description

Brushed surface;
Single bowl;
With sound pad and undercoating;
Optional accessories:
Drainer, Colander, Chopping board, Grid,
Rollmat, Soap dispenser, Wire basket.

KITCHEN SINK 952171

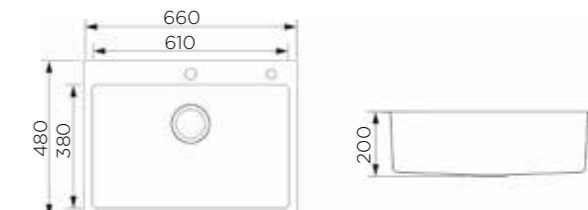

Information

Product Dimension (LxWxD)	660x480x200mm
Material	SS#304
Thickness	1.0mm
Corner	Radius 15
Cutout size (Topmount)	640mmx460mmxR10

Description

Brushed surface;
Single bowl;
With sound pad and undercoating;
Optional accessories:
Drainer, Colander, Chopping board, Grid,
Rollmat, Soap dispenser, Wire basket.

KITCHEN SINK 951256

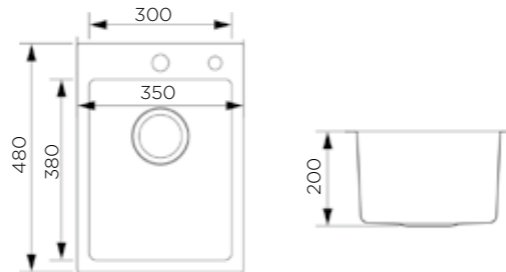

Information

Product Dimension (LxWxD)	350x480x200mm
Material	SS#304
Thickness	1.0mm
Corner	Radius 15
Cutout size (Topmount)	460mmx330mmxR15

Description

Brushed surface;
Single bowl;
With sound pad and undercoating;
Optional accessories:
Drainer, Colander, Chopping board, Grid,
Rollmat, Soap dispenser, Wire basket.

KITCHEN SINK 953352

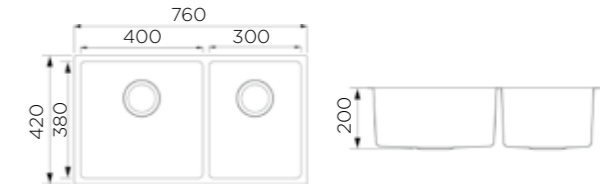

Information

Product Dimension (LxWxD)	760x420x200mm
Material	SS#304
Thickness	1.0mm
Corner	Radius 15
Cutout size (Topmount)	740mmx400mmxR15
Cutout size (Undermount)	725mmx385mmxR15

Description

Brushed surface;
Double bowl;
With sound pad and undercoating;
Optional accessories:
Drainer, Colander, Chopping board, Grid,
Rollmat, Soap dispenser, Wire basket.

KITCHEN SINK 951257

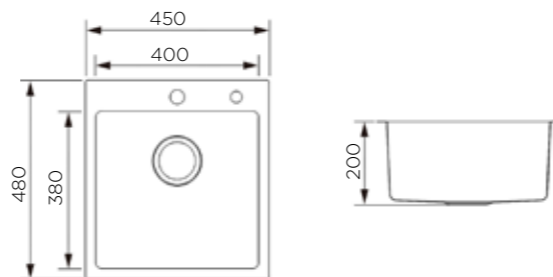

Information

Product Dimension (LxWxD)	450x480x200mm
Material	SS#304
Thickness	1.0mm
Corner	Radius 15
Cutout size (Topmount)	430mmx460mmxR10

Description

Brushed surface;
Single bowl;
With sound pad and undercoating;
Optional accessories:
Drainer, Colander, Chopping board, Grid,
Rollmat, Soap dispenser, Wire basket.

KITCHEN SINK 953353

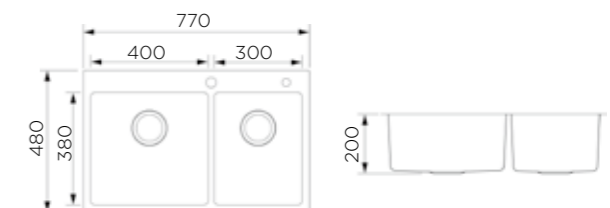

Information

Product Dimension (LxWxD)	770x480x200mm
Material	SS#304
Thickness	1.0mm
Corner	Radius 15
Cutout size (Topmount)	750mmx460mmxR15

Description

Brushed surface;
Double bowl;
With sound pad and undercoating;
Optional accessories:
Drainer, Colander, Chopping board, Grid,
Rollmat, Soap dispenser, Wire basket.



PRESSING SINKS

Intelligent Kitchen Sink

Pressing sinks or so-called drawn sinks or machine sinks are stamped by toolings. Its thickness ranges from 0.6mm to 1.0mm with numerous designs.

People love it for various reasons, namely, artistic-looking, beautiful curve and the unique sense of integration...

If these advantages are not enough to fascinate you, there are more to come, such as easy to handle, energy saving and cost efficient.

Higold pressing sinks, born for perfectionists only!

Drawn Kitchen Sink

In the hands of the international fashion masters, even a small metal decorative piece could also be clever to make thoughts. Unique shape, access to visual enjoyment but also have a superior quality. Placed in space regardless of any corner, people can not ignore.



Pressing Kitchen Sink



DESIGN

The double sink design takes full account of the different needs of the kitchen and adds agility to kitchen life. Elegance is evident in such a confined space.

TECHNIQUE

Adopting one-piece stretch forming process, the product is flawless, seamless (no joints, watertight) and durable.

QUALITY

304 stainless steel sheets are used. With cold stretching technology, steel sheets are stretched at room temperature and the material is more stable and durable.

FUNCTION

The double sink design realizes reasonable space matching, allowing you to freely enjoy comfortable life in a more scientific space.

FEATURES

HIGOLD uses a simpler water drainage system with higher reliability, large-diameter drainage pipe, stainless steel drainage lift cage, making the sink easier to drain water and remove slags.



KITCHEN SINK 920082 ✓

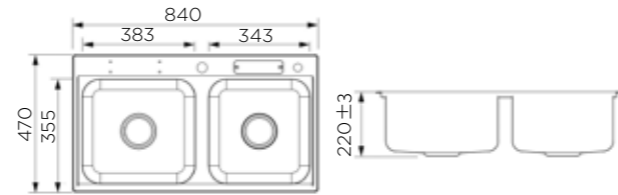

Information

Product Dimension (LxWxD) 840x470x220mm
 Material SS#304
 Thickness 0.8mm
 Cutout size (Topmount) 820mmx450mmxR10

Description

Brushed surface;
 Double bowl;
 With sound pad and undercoating;
 Optional accessories:
 Drainer, Chopping board, Soap dispenser,
 Wire basket.

KITCHEN SINK 920013

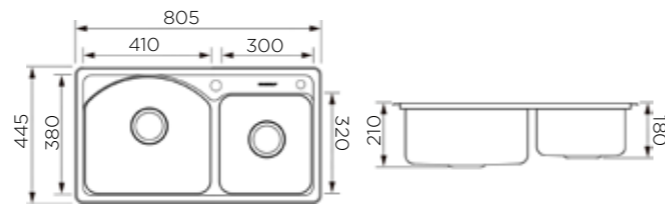

Information

Product Dimension (LxWxD) 805x445x210mm
 Material SS#304
 Thickness 0.8mm
 Cutout size (Topmount) 790mmx420mmxR10

Description

Brushed surface;
 Double bowl;
 With sound pad and undercoating;
 Optional accessories:
 Drainer, Chopping board, Soap dispenser,
 Wire basket.

KITCHEN SINK 920156

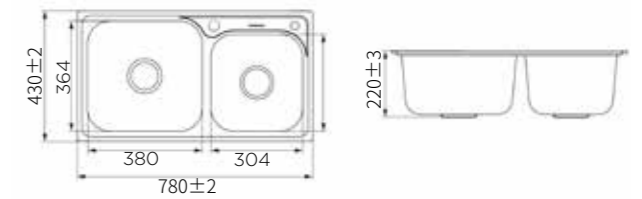

Information

Product Dimension (LxWxD) 780x430x220mm
 Material SS#304
 Thickness 0.8mm
 Cutout size (Topmount) 755mmx405mmxR10

Description

Brushed surface;
 Double bowl;
 With sound pad and undercoating;
 Optional accessories:
 Drainer, Chopping board, Wire basket.

KITCHEN SINK 920059

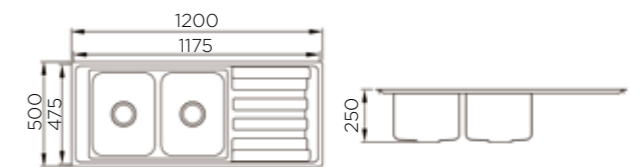

Information

Product Dimension (LxWxD) 1200x500x250mm
 Material SS#304
 Thickness 0.8mm
 Cutout size (Topmount) 1175x475mm

Description

Brushed surface;
 Double bowl with tray;
 With sound pad and undercoating;
 Optional accessories:
 Drainer, Chopping board, Soap dispenser,
 Wire basket.

KITCHEN SINK 920098

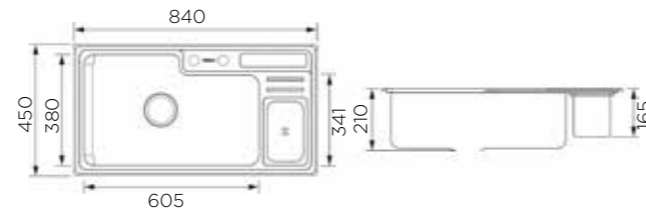

Information

Product Dimension (LxWxD)	840x450x210mm
Material	SS#304
Thickness	0.8mm
Cutout size (Topmount)	815mmx425mmxR25

Description

Brushed surface;
Single bowl;
With sound pad and undercoating;
Standard accessories:
Drainer, Chopping board, Knife holder,
Garbage bin, Wire basket.

KITCHEN SINK 920039

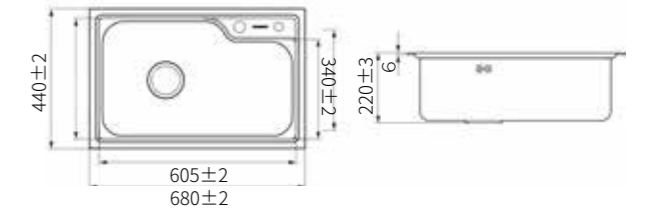

Information

Product Dimension (LxWxD)	680x440x220mm
Material	SS#304
Thickness	0.8mm
Cutout size (Topmount)	655mmx415mmxR10

Description

Brushed surface;
Single bowl;
With sound pad and undercoating;
Optional accessories: Drainer;

KITCHEN SINK 920004

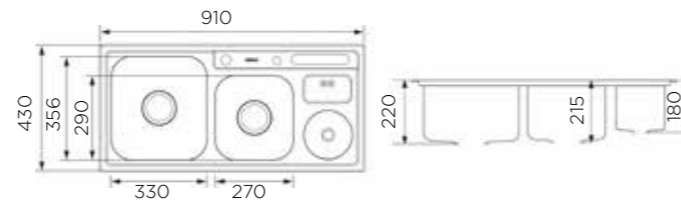

Information

Product Dimension (LxWxD)	910x430x220mm
Material	SS#304
Thickness	0.8mm
Cutout size (Topmount)	895mmx405mmxR20

Description

Brushed surface;
Double bowl;
With sound pad and undercoating;
Standard accessories:
Drainer, Chopping board, Knife holder,
Garbage bin, Wire basket.

KITCHEN SINK 920102

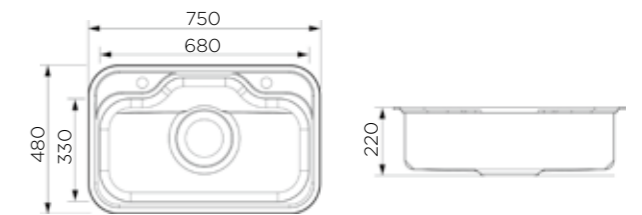

Information

Product Dimension (LxWxD)	750x480x220mm
Material	SS#304
Thickness	0.8mm
Cutout size (Topmount)	820x450mm

Description

Brushed surface;
Single bowl;
With sound pad and undercoating;
Standard accessories:
Drainer, Chopping board, Soap dispenser.

KITCHEN SINK 920034

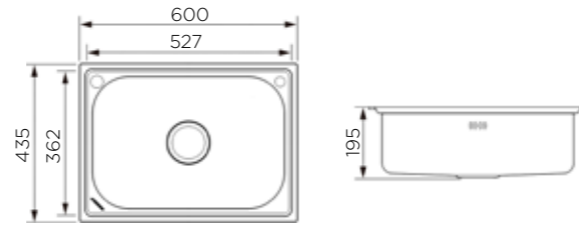

Information

Product Dimension (LxWxD)	600x435x195mm
Material	SS#304
Thickness	0.8mm
Cutout size (Topmount)	575mmx410mmxR10

Description

Brushed surface;
Single bowl;
With sound pad and undercoating;
Optional accessories: Drainer;

KITCHEN SINK 920069

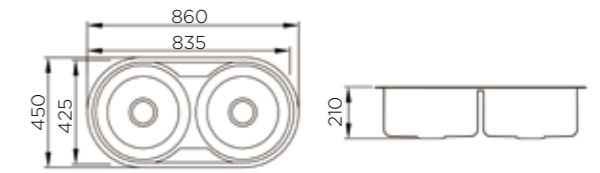

Information

Product Dimension (LxWxD)	860x450x210mm
Material	SS#304
Thickness	0.8mm
Cutout size (Topmount)	840mmx430mmxR215

Description

Brushed surface;
Double bowl;
With sound pad and undercoating;
Optional accessories: Drainer;

KITCHEN SINK 920032

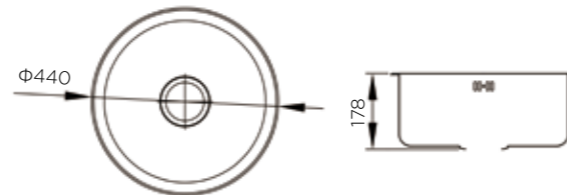

Information

Product Dimension (LxWxD)	Φ440x178mm
Material	SS#304
Thickness	0.8mm
Cutout size (Topmount)	Φ415

Description

Brushed surface;
Single bowl;
With sound pad and undercoating;
Optional accessories: Drainer;

KITCHEN SINK 920070

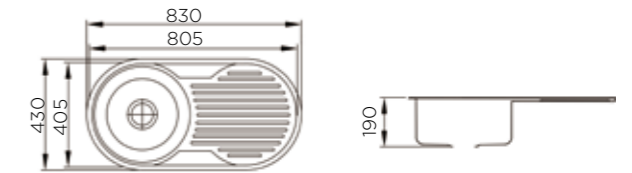

Information

Product Dimension (LxWxD)	830x430x190mm
Material	SS#304
Thickness	0.8mm
Cutout size (Topmount)	810mmx410mmxR205

Description

Brushed surface;
Single bowl with tray;
With sound pad and undercoating;
Optional accessories: Drainer;



KITCHEN FAUCETS

Intelligent
Kitchen Faucet

Every Higold sink deserves a premium faucet to be perfect.

Higold faucet collection offers a rich variety of options, ranging from pullout, non-pullout, brass, stainless steel or PVD applied. Customization is possible on large quantities.

Don't take Higold faucet as a side course, it is the core of kitchen, from where, your cooking story begins.

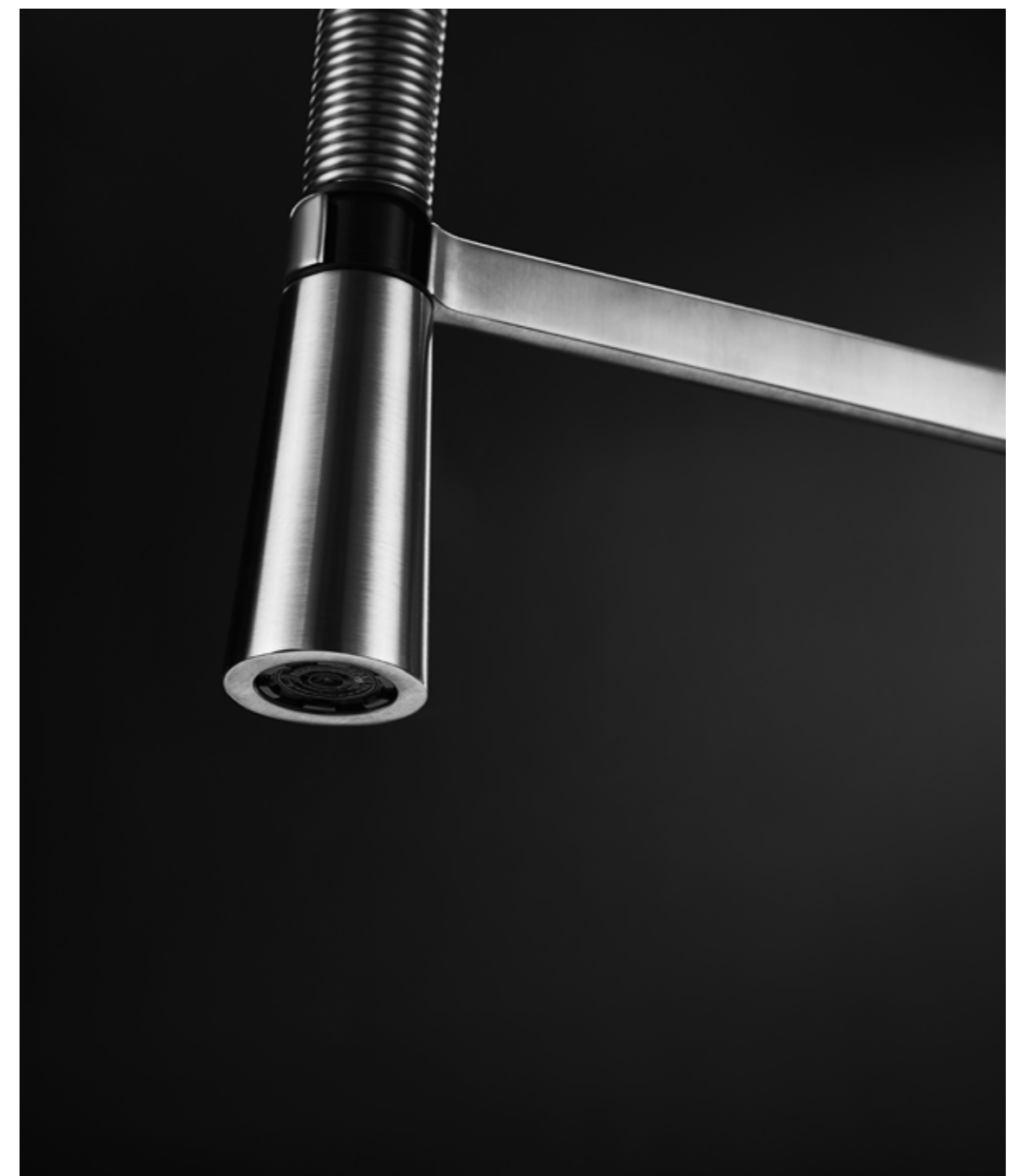

Kitchen Faucet

Elegant life always starts from the wonderful experience. With water flow slowly, you can feel the enthusiasm to the life.



KITCHEN FAUCET



ITEM NO. 980039

Product Size: 230x425mm;
Brass with brushed PVD;
Cold/Hot water;
Pull-out hose;

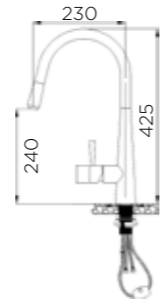

ITEM NO. 980087

Product Size: 226x420mm;
304 stainless steel;
Cold/Hot water;
Pull-out hose;

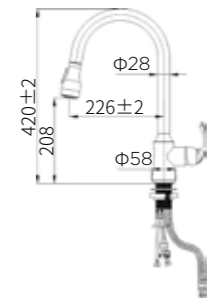

ITEM NO. 980040

Product Size: 225x460mm;
Brass with chrome plated;
Cold/Hot water;
Pull-out hose;

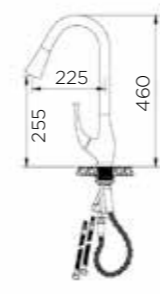

ITEM NO. 980094

Product Size: 285x478mm;
304 stainless steel;
Cold/Hot water;
Pull-out hose;

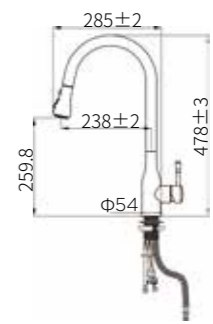

ITEM NO. 980041

Product Size: 216x550mm;
Brass with brushed PVD;
Cold/Hot water;
Pull-out hose;

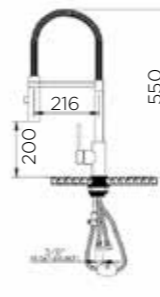

ITEM NO. 980099

Product Size: 290x415mm;
304 stainless steel;
Cold/Hot water;
Pull-out hose;

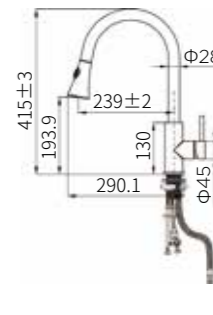

ITEM NO. 980045

Product Size: 230x420mm;
Brass with brushed PVD;
Cold/Hot water;
Pull-out hose;

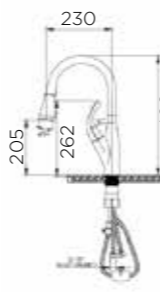

ITEM NO. 980062

Product Size: 238x410mm;
Brass with chrome plated;
Cold/Hot water;

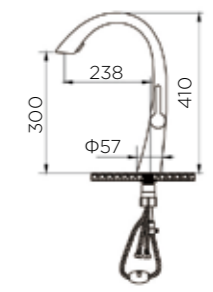

KITCHEN FAUCET



ITEM NO. 980017
 Product Size: 265x270mm;
 Brass with black painting;
 Cold/Hot water;

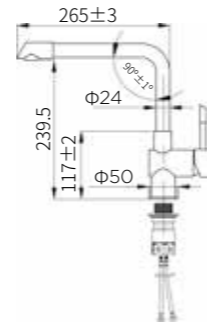

ITEM NO. 980104
 Product Size: 190x337mm;
 304 stainless steel;
 Cold/Hot water;

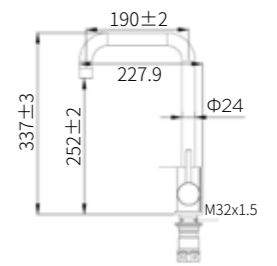

ITEM NO. 980024
 Product Size: 210x520mm;
 Brass with brushed PVD;
 Cold/Hot water;

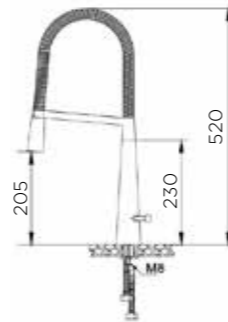

ITEM NO. 980106
 Product Size: 205x378mm;
 304 stainless steel;
 Cold/Hot water;

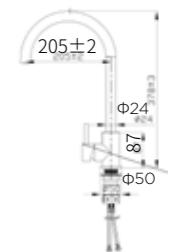

ITEM NO. 980096
 Product Size: 280x630mm;
 304 stainless steel;
 Cold/Hot water;

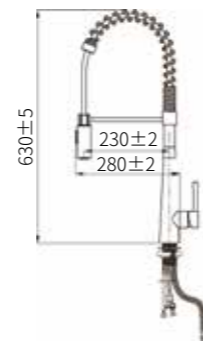

ITEM NO. 980032
 Product Size: 245x325mm;
 304 stainless steel;
 Cold/Hot/Boiling water;

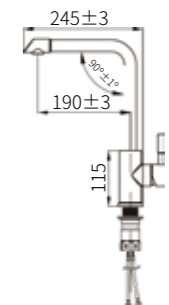

ITEM NO. 980003
 Product Size: 228x318mm;
 304 stainless steel;
 Cold/Hot water;

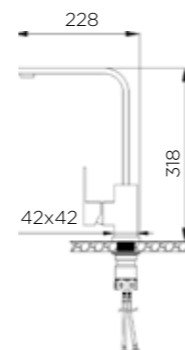

ITEM NO. 980008
 Product Size: 227x390mm;
 304 stainless steel;
 Cold/Hot water;

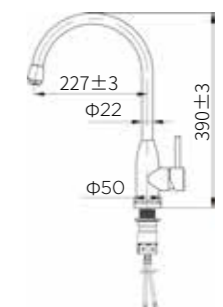

ACCESSORIES

Kitchen Accessories

Accessories serve as supplement to sinks functionally or aesthetically.

We offer various accessories to pair the sinks, such as chopping board ; rollmat; soap dispenser; grid; colander etc.

Good is not enough, You deserve better!

WATER DRAINAGE



ITEM NO. 981001
Drainer head (1.5")
+ Hard Pipe
For single bowl



ITEM NO. 981003
Drainer head (1.5")
+ Hard Pipe
For double bowl



ITEM NO. 981002
Drainer head (2")
+ Soft Pipe
For single bowl



ITEM NO. 981004
Drainer head (2")
+ Soft Pipe
For double bowl



ITEM NO. 981014
Drainer head (2")
+ Soft Pipe
For single bowl



ITEM NO. 981015
Drainer head (2")
+ Soft Pipe
For double bowl



ITEM NO. 981085
Rear Drainer Set
(Head 2" +pipe)
For single bowl



ITEM NO. 981086
Rear Drainer Set
(Head 2" +pipe)
For double bowl

DRAINER



ITEM NO. 981001-100
Drainer head (1.5")



ITEM NO. 981022-100
Drainer head (2")



ITEM NO. 981067
Drainer head (1.5")



ITEM NO. 981047
Drainer head (2")

GRID & COLANDER



ITEM NO. 982001
Wire basket



ITEM NO. 984001
Stainless steel colander
(size adjustable)

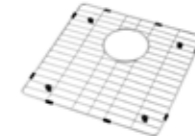

ITEM NO. 982004
Bottom Grid
(size adjustable)



ITEM NO. 982055
Bottom Grid
(size adjustable)

CHOPPING BOARD



ITEM NO. 983011
chopping board
Oak



ITEM NO. 983027
chopping board
Bamboo



ITEM NO. 983002
chopping board
Sapele



ITEM NO. 983044
chopping board
Sapele

SOAP DISPENSER & ROLLMAT



ITEM NO. 985001
Soap Dispenser
Plastic bottle



ITEM NO. 985003
Soap Dispenser
Plastic bottle



ITEM NO. 987013
Square-bar Rollmat
(Size adjustable)

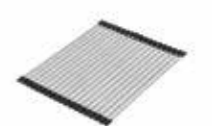

ITEM NO. 987017
Round-bar Rollmat
(Size adjustable)

INSTALLATION

Most of HIGOLD sinks apply to three typical installation style, Topmount, Undermount and Flushmount, which require different clips and cutout sizes. Anyhow, they have one thing in common: Easy to Install.

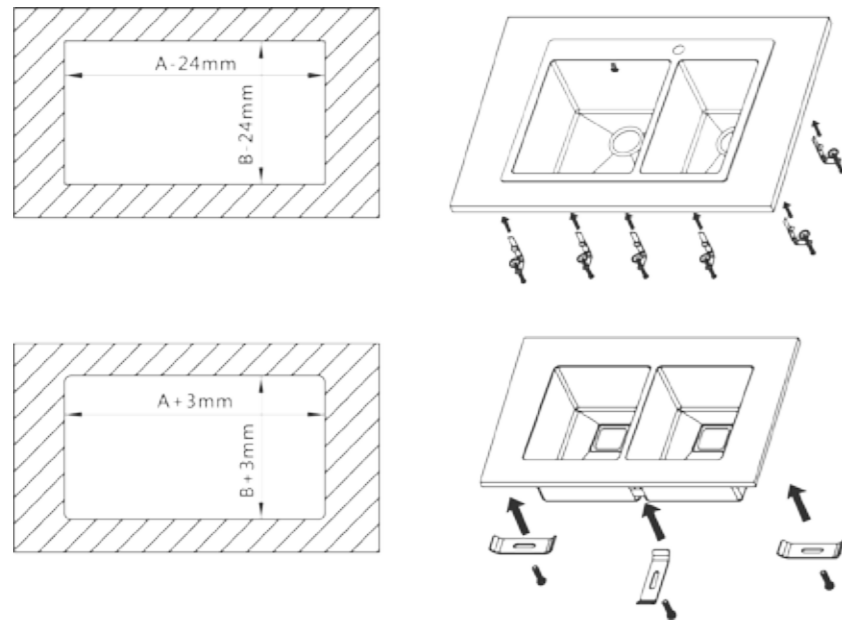

INSTALLATION METHOD

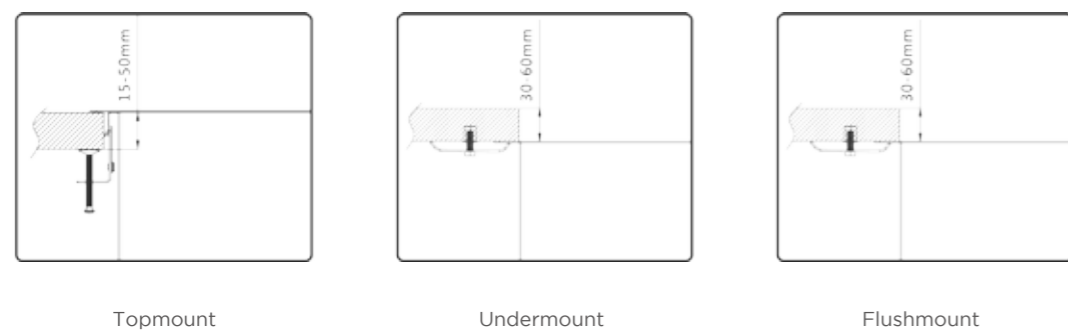

PACKAGE METHOD

Regular Packing Single carton

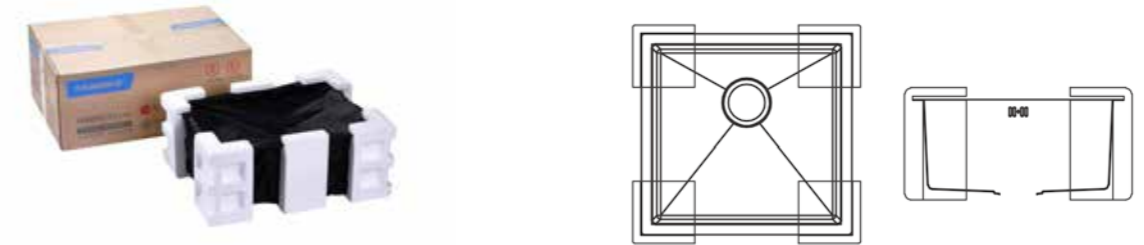

Item	901008 (product size: 508x483x228mm)
Carton qty.	1pc
20'	336pcs
40'	672pcs
40'HQ	756pcs
Remarks	Applicable for all types of sinks

Cost-Saving Packing Stacking Pallet

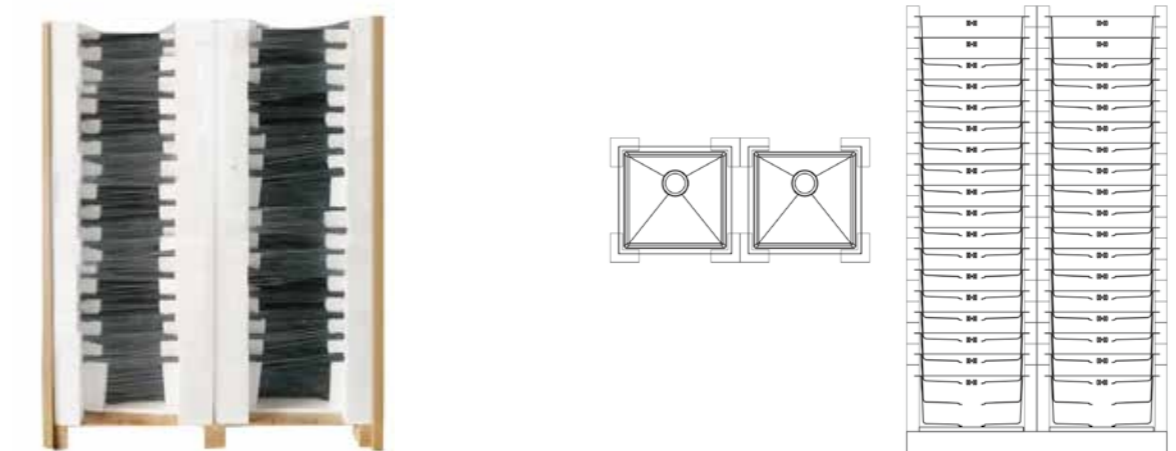

Item	901008 (product size: 508x483x228mm)
Pallet qty.	72pc
20'	648pcs
40'	1296pcs
40'HQ	1368pcs
Remarks	Not applicable for sinks with tray and apron sinks

